



COMPOUND SEMICONDUCTOR

Connecting the Compound Semiconductor Community

Volume 25 Issue 5 JUNE 2019

@compoundsemi

www.compoundsemiconductor.net

Interband cascade lasers target the mid-infrared



Delivering powerful blue lasers to the factory floor



Building better lasers on low-cost silicon



Bear market drags down many CS shares



Exagan reaches out to global markets

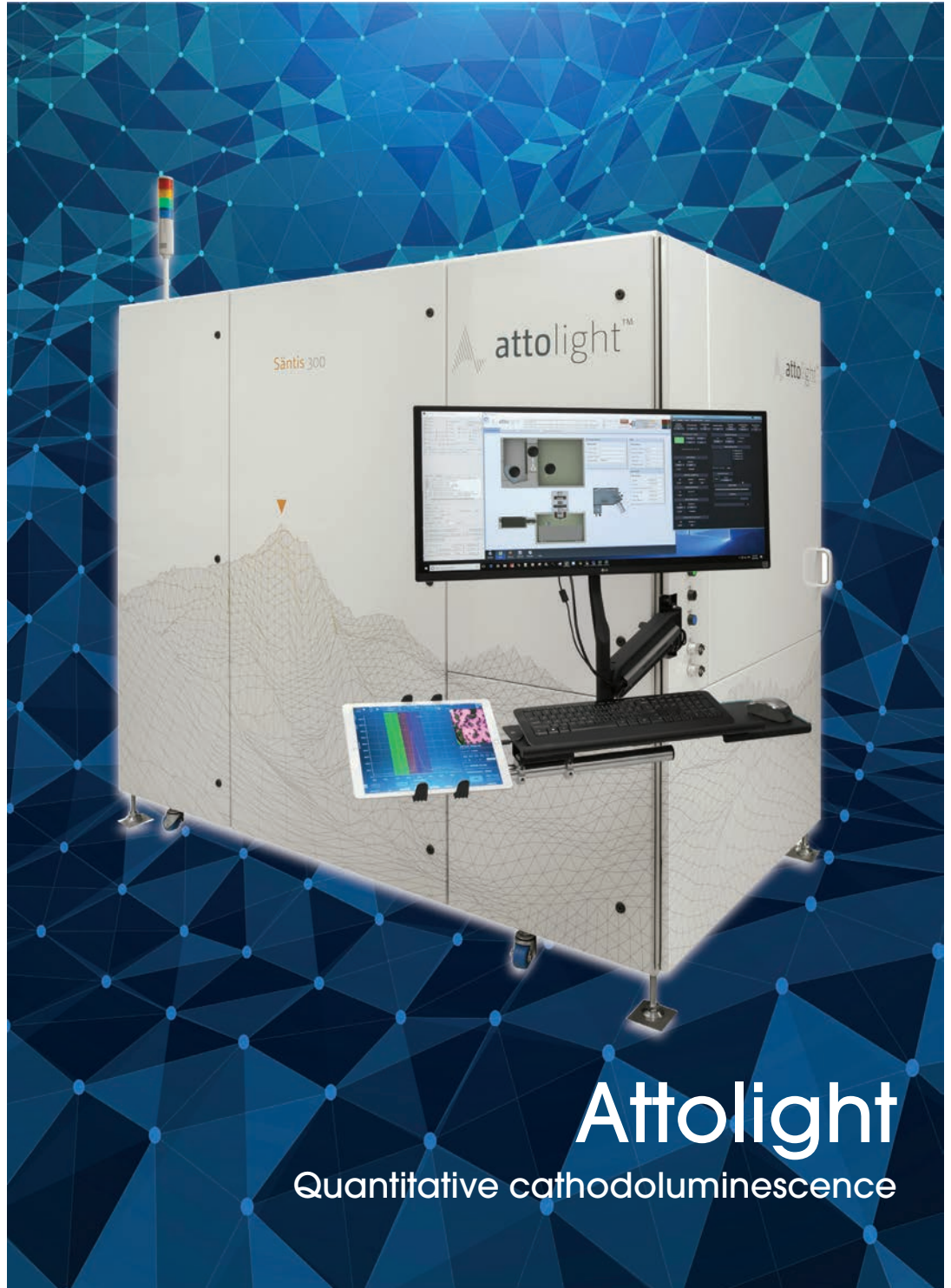

Attolight

Quantitative cathodoluminescence

inside

News Review, News Analysis, Features, Research Review, and much more...
Free Weekly E News round up go to: www.compoundsemiconductor.net

AN ANGEL BUSINESS COMMUNICATIONS PUBLICATION



Global mega trends require best performance III-V materials

AIX 2800G4-TM

- 3D sensing
- Augmented reality
- Autonomous driving
- Cloud computing
- Internet of things
- Next generation displays

Discover the MOCVD tool of record for AsP-based applications



Made
in
Germany



AIXTRON

info@aixtron.com
www.aixtron.com

Viewpoint



By Dr Richard Stevenson, Editor

No let up for innovation

THE SEMICONDUCTOR diode laser is one of our industry's most mature devices. Originating in 1962 in the research labs of both General Electric and the IBM T.J. Watson Centre, it has been produced in vast quantities over the intervening years, providing the key ingredient in CD players, laser printers and optical communication systems. What's more, it has revolutionised industrial welding and cutting.

Given all this success, there will be some that think that no more development of the device is needed. But, of course, you and I know different.

Take, for example, the field of silicon photonics. While silicon has many virtues, including its low cost and high purity, it's a lousy light emitter. III-Vs are needed to bring lasing to the circuit, a task that is not easy, so demands innovation. There has been much progress to date, but it's often involved some side-stepping of the foundation, using off-cut silicon substrates or silicon-on-insulator technologies.

For silicon photonics to hit the mainstream, the lasers will need to be added to bog-standard silicon. And in the pages that follow, you can read about two ways to do it: there's a wafer-bonding approach, pioneered by a team at Samsung Advanced Institute of Technology (see p.40); and an epitaxial approach that involves forming quantum dot lasers, developed by Kai May Lau and her team at the Hong Kong University of Science and Technology (see p.54).

Another area requiring innovation is the welding and cutting of copper. Whack this with infrared light, and little is absorbed – until a melt pool is created, absorption rockets and spatter results. What's needed is to move a blue source, as absorption is far higher here. This approach is now possible thanks to development at Nuburu (see p.34). Engineers at this US start-up have learnt how to couple the light together from an array of GaN laser diodes, each emitting a few watts, to produce a powerful source.



If a GaN laser diode emits a narrow linewidth, it can also be considered for sensing, atomic clocks, and underwater wireless optical communications. Developing such a laser, by adding a distributed feedback grating to a green edge-emitter made by Osram, are Boon Ooi and co-workers from the King Abdullah University of Science and Technology, Saudi Arabia (see p.60).

Even with great innovation, lasers made from the more common material families can only get you so far. To hunt for molecules such as methane, you need a mid-infrared source. Offering a solution are interband cascade lasers made from antimonides, a technology pioneered by Rui Yang, now at the University of Oklahoma (see p.48).

So, as this issue highlights, laser innovation is rife within our community.

Editor Richard Stevenson richardstevenson@angelbc.com +44 (0)1291 629640
Contributing Editor Rebecca Pool editorial@rebeccapool.com
News Editor Christine Evans-Pughe chrise-p@dircon.co.uk
Sales Executive Jessica Harrison jessica.harrison@angelbc.com +44 (0)2476 718970
USA Representatives Tom Brun Brun Media tbrun@brunmedia.com +001 724 539-2404
Janice Jenkins jjenkins@brunmedia.com +001 724-929-3550
Publisher Jackie Cannon jackie.cannon@angelbc.com +44 (0)1923 690205
Director of Logistics Sharon Cowley sharon.cowley@angelbc.com +44 (0)1923 690200
Design & Production Manager Mitch Gaynor mitch.gaynor@angelbc.com +44 (0)1923 690214

Circulation Director Jan Smoothery jan.smoothery@angelbc.com +44 (0)1923 690200
Chief Executive Officer Stephen Whitehurst stephen.whitehurst@angelbc.com +44 (0)2476 718970

Directors Bill Dunlop Uprichard – EC, Stephen Whitehurst – CEO, Jan Smoothery – CFO, Jackie Cannon, Scott Adams, Sharon Cowley, Sukhi Bhadal

Published by Angel Business Communications Ltd, Unit 6, Bow Court, Fletchworth Gate, Burnsall Road, Coventry CV5 6SP, UK. T: +44 (0)2476 718 970 E: info@angelbc.com



Compound Semiconductor is published eight times a year on a controlled circulation basis. Non-qualifying individuals can subscribe at: £105.00/e158 pa (UK & Europe), £138.00 pa (air mail), \$198 pa (USA). Cover price £4.50. All information herein is believed to be correct at time of going to press. The publisher does not accept responsibility for any errors and omissions. The views expressed in this publication are not necessarily those of the publisher. Every effort has been made to obtain copyright permission for the material contained in this publication. Angel Business Communications Ltd will be happy to acknowledge any copyright oversights in a subsequent issue of the publication. Angel Business Communications Ltd © Copyright 2019. All rights reserved. Contents may not be reproduced in whole or part without the written consent of the publishers. The paper used within this magazine is produced by chain of custody certified manufacturers, guaranteeing sustainable sourcing. US mailing information: Compound Semiconductor, ISSN 1096-598X, is published 8 times a year, Jan/Feb, March, April/May, June, July, August/September, October, November/ December by Angel Business Communications Ltd, Unit 6, Bow Court, Fletchworth Gate, Burnsall Rd, Coventry CV5 6SP UK. The 2019 US annual subscription price is \$198. Airfreight and mailing in the USA by agent named Air Business Ltd, c/o WN Shipping USA, 156-15, 146th Avenue, 2nd Floor, Jamaica, NY 11434, USA. Periodicals postage paid at Jamaica NY 11431. US Postmaster: Send address changes to Compound Semiconductor, Air Business Ltd, c/o WN Shipping USA, 156-15, 146th Avenue, 2nd Floor, Jamaica, NY 11434, USA. Printed by: The Manson Group. ISSN 1096-598X (Print) ISSN 2042-7328 (Online) © Copyright 2019.

We strive for accuracy in all we publish; readers and contributors are encouraged to contact us if they recognise an error or omission. Once a magazine edition is published [online, in print or both], we do not update previously published articles to align old company names, branding, marketing efforts, taglines, mission statements or other promotional verbiage, images, or logos to newly created or updated names, images, typographic renderings, logos (or similar) when such references/images were accurately stated, rendered or displayed at the time of the original publication. When companies change their names or the images/text used to represent the company, we invite organizations to provide Angel Business Communications with a news release detailing their new business objectives and/or other changes that could impact how customers/prospects might recognise the company, contact the organisation, or engage with them for future commercial enterprise.

C CONTENTS

18 COVER STORY

Quantitative cathodoluminescence streamlines chip production

Cathodoluminescence offers a quick, non-invasive approach to determining alloy compositions, exposing defects and uncovering surface contamination

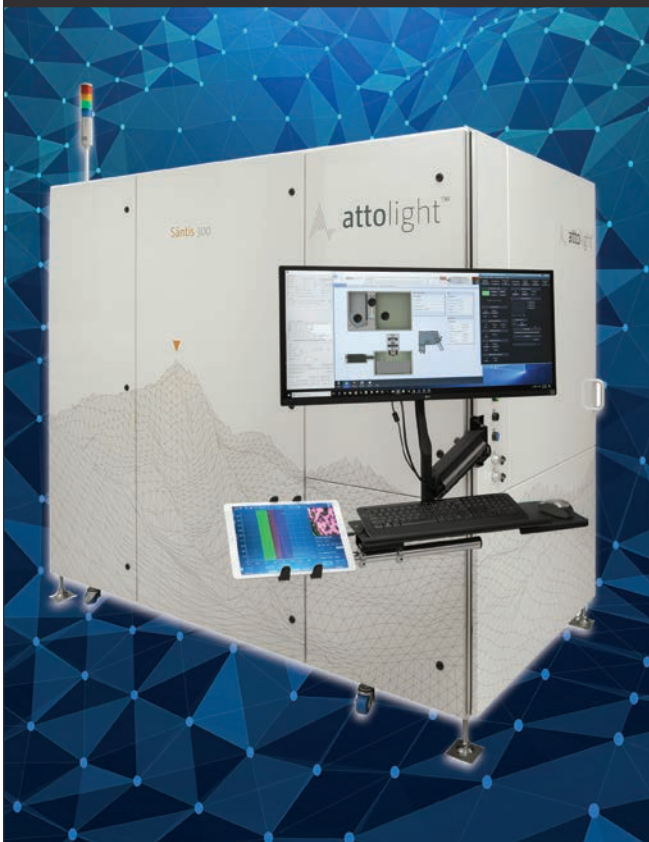

24 Cree and Infineon buck the trend

The share prices of many compound semiconductor companies have taken a battering over the last twelve months. But that's not the case for Cree and Finisar – their valuations are soaring.

30 IRPS increase coverage of SiC and GaN

Reliability conference covers degradation in commercial 1200 V MOSFETs, a method for surge rating GaN FETs, and an approach to predicting the lifetime of GaN HEMTs

34 Delivering powerful blue lasers to the factory floor

Powerful blue lasers are ideal for welding copper, because they hit the sweet spot for light absorption

40 Building better lasers on low-cost silicon

The silicon photonics revolution is gathering pace, thanks to the introduction of powerful lasers that don't require an insulating intermediary layer

48 Interband cascade lasers target the mid-infrared

Inventor of the interband cascade laser, Rui Q. Yang from the University of Oklahoma, details the progress of this powerful, efficient mid-infrared light source that combines the best assets of laser diodes and QCLs

54 Dots and wells deliver lasing on silicon

Spurring the development of silicon photonics is the world's first InP-based laser grown on exactly orientated silicon

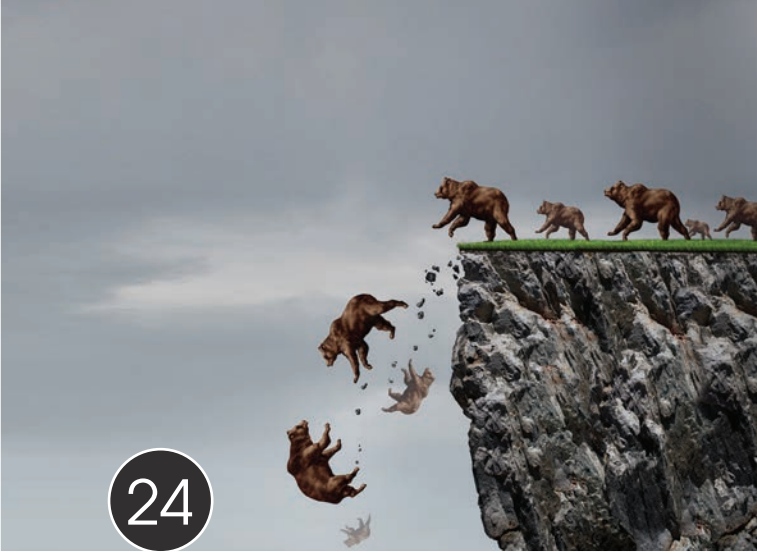

24

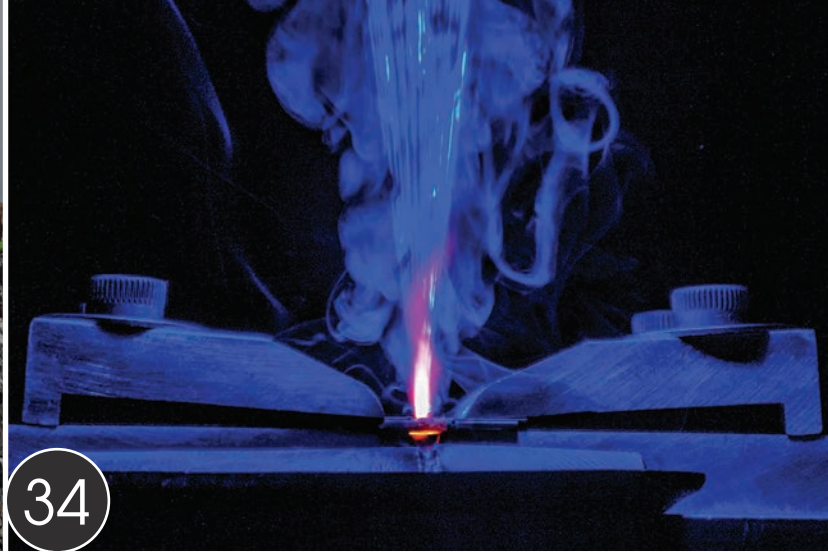

34

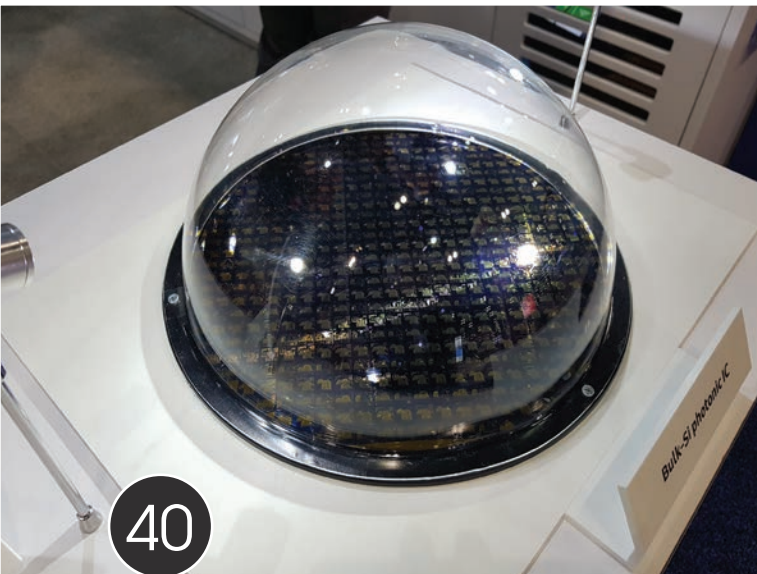

40



48

news

- 06 Cree to invest \$1billion in SiC fab and materials factory
- 07 Osram adds quantum dots to make LEDs more efficient
- 08 IQE mega foundry gets first VCSEL order
- 09 Cree selected as SiC partner for Volkswagen
- 10 Vuzix and Plessey sign long-term MicroLED agreement
- 11 HexaTech makes defect-free 2-inch AlN substrate
- 12 X-Celeprint makes microLED display using RPCVD



12

news analysis

- 14 **Ahead of the pack**
EPC's Alex Lidow believes his GaN devices now beat silicon on performance and price
- 16 **Exagan reaches out to global markets**
With its second Power Solutions Centre launched, Exagan is ready to bring GaN-on-silicon devices to the masses



16

research review

- 59 **Refining the sodium-flux method**
Eliminating oxygen allows seeds of GaN to provide the requisite foundation for subsequent HVPE growth
- 60 **Narrowing the linewidth of the green laser**
A distributed feedback grating enhances the spectral purity of the green, nitride-based laser
- 61 **Cubic GaN promises to address the green gap**
Switching from hexagonal to cubic GaN could create more efficient green LEDs with reduced droop



Cree to invest \$1 billion in SiC fab and materials factory

AS PART of its long-term growth strategy, Cree will invest up to \$1 billion in the expansion of its SiC capacity with the development of a state-of-the-art, automated 200 mm SiC fabrication facility and a materials mega factory at its US campus headquarters in Durham, N.C.

It marks the company's largest investment to date in fuelling its Wolfspeed SiC and GaN on SiC business. Upon completion in 2024, the facilities will substantially increase the company's SiC materials capability and wafer fabrication capacity, allowing wide bandgap semiconductor solutions that enable the dramatic technology shifts underway within the automotive, communications infrastructure and industrial markets.

"We continue to see great interest from the automotive and communications infrastructure sectors to leverage the benefits of SiC to drive innovation. However, the demand for SiC has long surpassed the available supply," said Gregg Lowe, CEO of Cree.

The company has undertaken its largest-ever investment in production

to dramatically increase this supply and help customers deliver transformative products and services to the marketplace.

"This investment in equipment, infrastructure and our workforce is capable of increasing our SiC wafer fabrication capacity up to 30-fold and our materials production by up to 30-fold compared to Q1 of fiscal year 2017, which is when we began the first phase of capacity expansion," said Lowe.

"We believe this will allow us to meet the expected growth in Wolfspeed SiC material and device demand over the next five years and beyond."

The plan delivers additional capacity for its Wolfspeed SiC business with the build out of an existing structure as a 253,000 square-foot, 200 mm power and RF wafer fabrication facility as an initial step to serve the projected market demand.

The new North Fab is designed to be fully automotive qualified and will provide nearly 18 times more surface area for manufacturing than exists today, initially

opening with the production of 150 mm wafers. The company will convert its existing Durham fabrication and materials facility into a materials mega factory.

"These SiC manufacturing mega-hubs will accelerate the innovation of today's fastest growing markets by producing solutions that help extend the range and reduce the charge times for electric vehicles, as well as support the rollout of 5G networks around the world," said Lowe.

"We believe that this represents the largest capital investment in the history of SiC and GaN technologies and production with a fiscally responsible approach. By using existing facilities and installing a majority of refurbished tools, we believe we will be able to deliver a state-of-the-art 200 mm capable fab at approximately one-third of the cost of a new fab."

The expanded campus also creates high-tech job opportunities and will serve as an advanced manufacturing workforce development initiative.





Osram adds quantum dots to make LEDs more efficient

LIGHT EMITTED by quantum dots depends on the size of the particles. When blue LED light hits quantum dot (QD) particles roughly 3 nm, they produce green light, while particles around 7 nm emit red light. This tuneable light conversion technology is now being used for the first time in the Osconiq S 3030 QD mid-power LED from Osram Opto Semiconductors.

The technology comes from Pacific Light Technologies (PLT) – an optical nano material company that Osram acquired a year ago. Osram says the PLT QD technology is enabling it to begin to close the efficacy gap that exists between CRI 80 and CRI 90 LEDs today.

Osram's new mid-power LED Osconiq S 3030 QD was specially developed for area lighting and downlight applications and will empower customers to realise luminaires with high efficacy and excellent colour rendering.

When manufacturing conventional white LEDs, the main objectives are efficacy and product quality. Considering both at the same time poses a particular challenge, especially with very high colour rendering indexes (CRI), where

developers with conventional converter technology have at times, reached their limits. QDs can solve this problem. The great advantage of using these nanoparticles is that the existing LED manufacturing processes remain the same. QDs are simply used instead of conventional phosphors when the converter material is applied.

The new Osconiq S 3030 includes a specially developed QD phosphor solution that enables CRI 90 to achieve an outstanding efficacy value of 173 lm/W at 3000 K – a best-in-class value for 0.2 W high-performance LEDs. The compact dimensions of 3.0 mm x 3.0 mm and the low thermal resistance enable simple system design. The Osconiq S 3030 QD is also available in various colour temperatures from 2,700 to 6,500 K.

Another unique feature of the PLT QD technology is that the Quantum Dots are encapsulated to protect them from moisture and other external influences that pose the greatest risk to the functionality of a LED. The special encapsulation technology allows the QDs to reliably master the demanding conditions of on-chip operation within the LED component.

Gartner ranks Aixtron as MOCVD market leader

DEPOSITION equipment firm Aixtron has announced that it has maintained its position as market leader for MOCVD equipment in 2018 according to market research company Gartner. This marks the third consecutive year in which Aixtron achieved the top position in the ranking.

Aixtron's share was 46 percent, followed by Veeco (USA) with 27 percent and AMEC (China) with 23 percent while the global MOCVD market grew to a total of \$553 million (2017: \$401 million) at the same time.

Aixtron MOCVD systems are used for high-volume production of lasers for 3D sensing and optical data communication as well as for specialty LEDs, compound solar cells and GaN power electronics or GaN RF applications in particular for the build out of the new 5G communication network.

Bernd Schulte, president of Aixtron SE, comments: "We focus on our core competence in MOCVD technology and have achieved market leadership in a number of highly attractive growth markets due to the strong performance of our systems. Our continued success is based on an application understanding developed over decades in cooperation with our customers.

"This strongly serves the continuous further development of our portfolio to best meet the specific requirements of the end markets – highest quality epitaxial layers combined with high efficiency in handling the precursors used for MOCVD processes. Thus we offer the lowest cost of ownership for high-volume manufacturing of compound semiconductor devices."





IQE mega foundry gets first VCSEL order

IQE has announced that its recently constructed Newport Mega Foundry has received its first mass production order from its leading existing VCSEL customer.

The achievement of full product qualification status is the result of extensive quality and process audits by the customer and their end OEM, as well as exhaustive product qualification trials including full reliability testing. Qualification of further tools is in progress and is expected to complete over the coming months.

In addition to the qualification with this customer, further VCSEL product qualifications are at advanced stages with more than ten other customers, two of which are expected to shortly reach a successful conclusion.

Customer feedback from the additional qualifications confirms the superior quality and performance from the new facility. The Newport Mega Foundry is the largest outsource epi facility for advanced compound semiconductors

globally and has been under construction for the last 18 months. It currently has ten large-scale production MOCVD tools installed, with space for up to an additional 90 tools. The manufacturing facility also houses an extensive suite of highly advanced wafer characterisation tools to ensure outstanding, world-class wafer quality.

The first ten tools are dedicated to 6-inch VCSEL production for end applications that include 3D sensing, high-speed datacoms, Advanced Driver Assistance Systems (ADAS), lidar, proximity sensing and Time of Flight (ToF) systems.

The market for VCSELS is expected to grow rapidly over the coming years as 3D sensing is installed across multiple user platforms, including facial recognition, world facing cameras for Augmented Reality (AR) and 3D photography, security cameras, industrial sensing and heating, ADAS, lidar, high-speed datacomms and proximity sensing.

Drew Nelson, CEO and president of IQE commented: "I am very pleased

to announce IQE receipt of full product qualification status from our leading VCSEL customer, and the first order for mass production from our new Mega Epi foundry in Newport.

"IQE has invested heavily, along with help from the Cardiff City Region Deal (CCR), to build the world's largest outsource epi facility, demonstrating our commitment to providing the capacity required for large scale deployment of VCSELS and other Compound Semiconductor (CS) products, as the CS industry moves through a real inflection point in volume manufacture.

"IQE is committed to leadership of this mass CS scaling, offering a unique range of wafer products and complementary technologies, enabling our customers to introduce disruptive products to the end marketplace. We have a powerful and extensive roadmap for VCSEL technology, which we believe will help the acceleration of the deployment of VCSELS across many end applications".

Soitec to acquire EpiGaN for €30 million

SOITEC, a Grenoble-based semiconductor materials firm, has entered into an agreement to acquire EpiGaN, a supplier of GaN epitaxial wafer materials, based in Hasselt, Belgium.

Soitec will pay €30 million in cash, plus an additional earn-out payment based on completion of certain milestones. EpiGaN's GaN products are used primarily within RF 5G, power electronics, and sensor applications, with the total addressable market of GaN technologies estimated to be between 500,000 to 1 million wafers per year within five years.

"GaN technology is gaining significant traction in RF and power markets. GaN epi-wafers represent a natural strategic fit with Soitec's current portfolio of engineered substrates," said Soitec CEO Paul Boudre. "The acquisition of EpiGaN further extends and complements Soitec's portfolio beyond silicon to create new value-added process solutions for both RF 5G and power systems."

In the mobility space the co-optimisation of performance, low power and cost is key. The arrival of 5G sub-6 GHz and mmW is driving new generations of base stations, compared with 4G, which in turn require more energy-efficient, higher performing, smaller, and more affordable PAs. Soitec will expand its engineered substrates offering for PA with GaN leading the way

in today's smaller, lighter, more efficient and cost effective base station designs.

"Widely recognised for its strong expertise in GaN for several years, EpiGaN has developed a technology which is ready and optimized for 5G broadband network applications," said EpiGaN co-founder and CEO Marianne Germain. "Our technology creates the unique opportunity for Soitec's customers to develop quickly product solutions targeting new high-growth markets, such as RF devices, efficient power switching devices and sensor devices."

"The GaN technology developed by EpiGaN opens up many future opportunities and we believe Soitec is an excellent partner to further develop the full potential of EpiGaN," said Kathleen Vandersmissen, director of EpiGaN and representative of cornerstone investor Investment Company of Limburg (LRM). In addition, the EpiGaN acquisition also creates new complementary growth opportunities across Soitec's existing Power-SOI products given GaN's use in power transistor designs. Both Power-SOI and GaN address the requirements for integrating high-voltage and analog functions in intelligent, energy-efficient and highly reliable power IC devices, for use in consumer electronics, data centre, automotive and industrial markets. EpiGaN will be integrated as one of Soitec's business units.



Cree selected as SiC partner for Volkswagen

CREE has been chosen as the exclusive SiC MOSFET partner for the Volkswagen Group's 'Future Automotive Supply Tracks' Initiative (FAST).

The aim of FAST is to work together to implement technical innovations quicker than before and to realise vehicle projects even more efficiently and effectively.

"The Volkswagen Group has committed to launch almost 70 new electric models in the next ten years, which is up from our pledge of 50 and increases the projected number of vehicles to be built on the Group's electric platforms from 15 million to 22 million in that timeframe. An effective network is our key to success. Our FAST partners are our strategic partners, each of them outstanding in their respective field. We want to shape the automotive future together." said Michael Baecker, head of Volkswagen purchasing connectivity.

This agreement connects the automotive industry's move from internal combustion engines to EVs and the growing adoption of SiC in the semiconductor market. It also drives innovation for both parties, enabling the Volkswagen Group to better serve their customers.

The use of SiC accelerates the automotive industry's transformation to electric vehicles, enabling greater system efficiencies that result in electric cars



Cree CEO, Gregg Lowe with Michael Baecker, head of Volkswagen purchasing connectivity, promoting the FAST Program partnership that aims to accelerate market transition to electric vehicles

with longer range and faster charging, while reducing cost, lowering weight and conserving space.

"Cree's technology is at the heart of the dramatic change underway in EVs, and we are committed to supporting the automotive industry as it transitions to more efficient, higher performing SiC-based solutions," said Gregg Lowe, CEO of Cree. "We are very honoured to be partnering with the Volkswagen Group. VW Group is a global power in the

automotive field with a strong commitment to electric vehicles, and this partnership will leverage the advantages of SiC to enable longer driving distances, shorter charge times and improved efficiency. We look forward to helping them deliver on the automobiles of the future."

The Volkswagen Group and Cree will be working with tier one and power module suppliers to engineer SiC-based solutions for future Volkswagen Group vehicles.

Advanced Compound Semiconductor Foundry Services

MOCVD • Fabrication • Testing

Advanced III-V semiconductor solutions for optoelectronics application in the biotechnology, telecommunications, energy, industrial, and defense industries.

MasimoSemiconductor.com | 603-595-8900



Vuzix and Plessey sign long-term MicroLED agreement

MicroLED firm Plessey and Vuzix, a US supplier of smart glasses and Augmented Reality (AR) technology, have announced an exclusive display device design and long-term supply agreement.

This agreement will support the development and production of next-generation AR products and solutions that combine Plessey's microLED light source technology with Vuzix' extensive expertise and IP in smart glasses and essential optics technologies.

Vuzix has already developed an evolving family of Smart Glasses culminating in the Vuzix Blade, the next generation smart display with a see-through viewing experience via its proprietary waveguide

optics. Formed from glass with precision nanostructures, the waveguide enables users to see high-resolution computer-generated graphics, images and information superimposed over images from the physical or real world.

Plessey says its microLED solution will significantly simplify existing smart glasses' complex optical system of red, green and blue light sources and their additional optics by replacing it with a single self-emitting display which has integrated micro-optical elements. Size, weight and power reduction are key considerations in the AR wearables market.

Existing light source systems have considerable losses all the way through

to the waveguide and the optical systems around them are bulky and complex, whereas an emissive microLED has very simple optical requirements, allowing for a much smaller footprint with minimal system losses by placing the light source directly in front of the waveguide.

Paul Travers, president and CEO at Vuzix, said: "We are very excited to expand our relationship with Plessey. Their microLED technology represents a key part of the solution needed to bring the form and functionality of Vuzix next-generation smart glasses to the look and feel of fashion forward glasses, solutions the world will be clamouring for."

Mike Lee, president of corporate and business development at Plessey, said: "By overcoming the difficulties of manufacturing microLEDs on a commercial scale, Plessey is playing a central role in providing next-generation technology to the Augmented Reality (AR) and display markets."

UnitedSiC adds seven SiC FETs to 650 V range

UNITEDSiC, a manufacturer of SiC power semiconductors, has added seven new TO220-3L and D2PAK-3L device/package combinations to its UJ3C (general purpose) and UF3C (hard switched) series of 650 V SiC FETs.



These new devices are said to provide new levels of high-voltage power performance in the fast growing data centre server, 5G base station, and electric vehicle markets, where they will be used in power supplies, telecom rectifiers, and on-board chargers respectively. The new devices will appeal to designers who prefer a 3-lead, TO220 or D2PAK package option, yet are still looking to enhance power performance in power-factor correction circuits, LLC resonant converters, and phase-shifted full-bridge converters.

UnitedSiC's UJ3C and UF3C FET portfolio are designed as drop-in replacements. Designers can significantly enhance system performance, without

the need to change gate drive voltage, by replacing their existing silicon IGBTs, silicon FETs, SiC MOSFETs or silicon superjunction devices with the UnitedSiC FETs.

Both series of SiC FETs are based on UnitedSiC's unique 'cascade' circuit configuration, in which a normally-on SiC JFET is co-packaged with a silicon MOSFET to produce a normally-off SiC FET device that has standard gate-drive characteristics. As a result, existing systems upgraded with the UnitedSiC 'drop-in replacement' FETs can expect a performance increase with lower conduction and switching losses, enhanced thermal properties and

integrated gate ESD protection. In the case of new designs, the UnitedSiC FETs deliver increased switching frequencies to gain substantial system benefits in both efficiency and reduction in size, and cost of passive components, such as magnetics and capacitors.

The three-lead, industry-standard TO220-3L package offers enhanced thermal characteristics made possible by UnitedSiC's sintered-silver packaging technology. New products available in this package include the UJ3C device with $R_{DS(on)}$ values of 30 m Ω and 80 m Ω , and the UF3C device with an $R_{DS(on)}$ spec of 40 m Ω .

The three-lead, industry-standard D2PAK-3L targets surface mount designs and is certified to IPC and JEDEC's Moisture Sensitivity Level 1. New products available in this package include the UJ3C device with $R_{DS(on)}$ specs of 30 m Ω and 80 m Ω , and UF3C devices with $R_{DS(on)}$ specs of 30 m Ω and 40 m Ω .

Select devices are also available in automotive versions that meet AEC-Q101.



HexaTech makes defect-free 2-inch AlN substrate

HEXATECH, a US supplier of single crystal AlN substrates, has announced the first known demonstration of a defect-free 2-inch diameter AlN substrate.

AlN substrates are used to make long-life UV-C LEDs for disinfection applications, deep UV lasers for biological threat detection, and high-voltage switching devices for efficient power conversion, and RF components for satellite communications.

HexaTech co-founder and CTO, Raoul Schlessler commented: "This is the largest known single crystal AlN substrate that is completely free of macroscopic defects, and accomplishes a long-standing goal as part of our 2-inch product development. Full-substrate reflection X-ray topography confirms this achievement, which will support and accelerate commercial production of high quality 2-inch material."

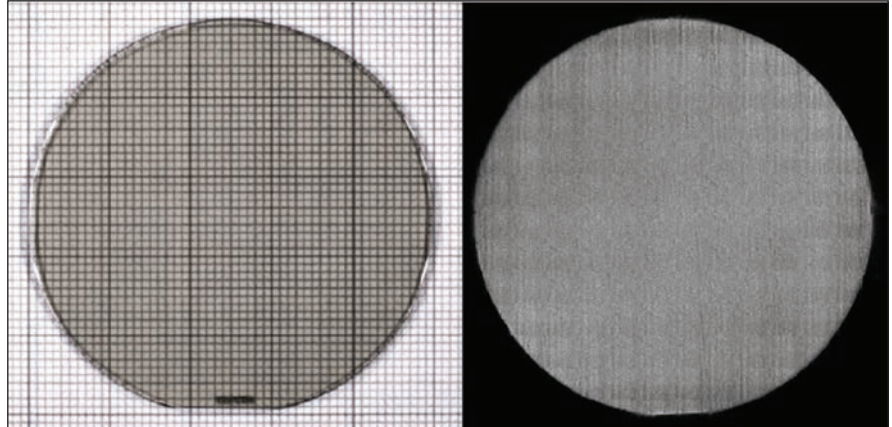

"Less than a year from our first 2-inch demonstration, reaching this level of perfection is a testament to the efforts of the entire HexaTech team, and highlights our relentless drive to provide our customers the ultimate in AlN substrate performance", stated HexaTech CEO, John Goehrke.

"This capability establishes a new baseline for sustaining our vision of continued diameter expansion and greater market adoption", he added. HexaTech's 2-inch diameter substrates, in addition to 35 mm and 25 mm substrates, are available now with standard lead times.

III/V-Reclaim GaAs InP

The most cost effective method to excellent quality.

"Now offering Germanium Reclaim"

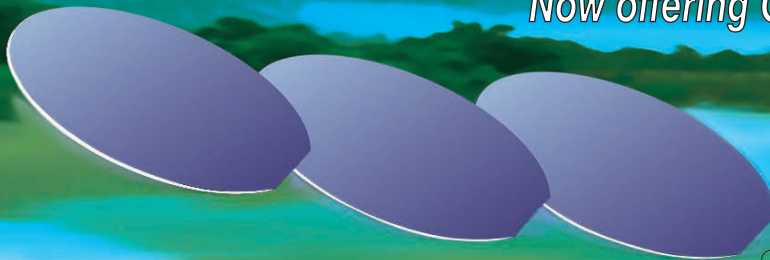

III/V-Reclaim

Wald 10
84568 Pleiskirchen / Germany
Telefon: + (49) 8728-911093
Telefax: + (49) 8728-911156
E-Mail: sales@35reclaim.com
Internet: www.35reclaim.com

- We recycle your GaAs and InP wafer (all formats and sizes)
- One and double side polished wafer
- Best surface quality for direct use in Epitaxy
- Backside thinning of fully structured wafer
- Thin wafer (60 μm)
- Single wafer processing possible
- We buy used wafer and sell recycled wafer



X-Celeprint makes microLED display using RPCVD

AUSTRALIAN semiconductor technology developer, BluGlass, together with its foundry customer the micro-transfer printing company, X-Celeprint, have implemented BluGlass' Remote Plasma Chemical Vapour Deposition (RPCVD) *p*-GaN technology in high performance microLED display prototypes.

BluGlass' foundry customer, X-Celeprint, is using RPCVD deposition for a unique technology demonstrations. X-Celeprint's active matrix microLED displays that use RPCVD *p*-GaN have demonstrated good luminance with colour uniformity, quantum efficiency and forward voltage that equals current high-performance commercial applications of 2000 cd m⁻².

X-Celeprint is a developer of micro-transfer printing (μ TP) technology. μ TP is a cost-effective and scalable manufacturing platform for integrating microscale devices such as lasers, LEDs or integrated circuits onto non-native substrates. They provide custom design services for micro-transfer printing stamps and printers for a range of customers.

BluGlass is commercialising a breakthrough semiconductor technology

called Remote Plasma Chemical Vapour Deposition (RPCVD) in the LED, microLED and power electronics industries. BluGlass' patented hardware and processes offers manufacturers unique performance advantages due to RPCVD's low temperature and low hydrogen growth conditions.

X-Celeprint has been a long-standing customer of BluGlass' foundry services and were the first adopter of RPCVD for microLED demonstrations.

X-Celeprint's VP of displays, Matt Meitl said: "X-Celeprint works with BluGlass to demonstrate our micro-transfer printing capability for microLED displays. BluGlass' creativity in epi-wafer design, unique capabilities in epitaxial growth, and dedication to continued product improvement make them a valuable development partner. We continue to

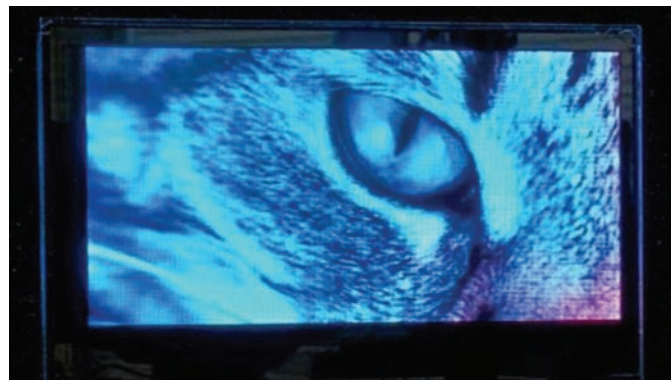

use these advantages in our micro-LED development."

BluGlass CTO, Ian Mann said: "It's rewarding after many years of developing RPCVD *p*-GaN to see our technology being trialed in customer devices, particularly for the emerging microLED display market. This microLED prototype demonstrates good performance and X-Celeprint are seeing the advantage of using RPCVD in their innovative products".

X-Celeprint continues to use BluGlass' RPCVD foundry services (early stage, fee-for-service revenue) to advance the technical demonstrations of their active matrix microLED displays.

Microchip expands SiC range of power devices

MICROCHIP has announced, via its Microsemi subsidiary, the production release of a family of SiC power devices that offer proven ruggedness and the performance benefits of wide-bandgap technology.

These products meet the need to improve system efficiency, robustness and power density in electric vehicles and other high-power applications in the industrial, aerospace and defence markets.

Microchip's 700 V SiC MOSFETs and 700 V and 1200 V SiC Schottky Barrier Diodes (SBDs) join its existing portfolio of SiC power modules. The over 35 discrete products that have been added to Microchip's portfolio are available in volume, supported by comprehensive development services,

tools and reference designs, and offer outstanding ruggedness proven through rigorous testing. The broad family of SiC die, discretes and power modules are offered across a range of voltage, current ratings and package types.

Microchip's SiC MOSFETs and SBDs are said to offer more efficient switching at higher frequencies and pass ruggedness tests at levels considered critical for guaranteeing long-term reliability.

The company's SiC SBDs perform approximately 20 percent better than other SiC diodes in these Unclamped Inductive Switching (UIS) ruggedness tests that measure how well devices withstand degradation or premature failure under avalanche conditions, which occur when a voltage spike exceeds the device's breakdown voltage.



Microchip's SiC MOSFETs also outperform alternatives in these ruggedness tests, demonstrating excellent gate oxide shielding and channel integrity with little lifetime degradation in parameters even after 100,000 cycles of Repetitive UIS (RUIS) testing.



Mission Microwave announces wideband K_a -band family

MISSION MICROWAVE TECHNOLOGIES introduced new wide-band K_a -band products at the SATELLITE 2019 industry event in the Walter E. Washington Convention Center Washington, DC.

The company has released a family of multi-band K_a -band BUCs to support LEO, MEO and GEO missions from a single switchable unit. Covering the range of 27.5 GHz to 30 GHz, these units will be electronically selectable in up to 6 bands covering current and anticipated frequency plans.

The new products are enhancements to the existing product lines, which already lead the industry in high power K_u -band BUC deployments for commercial and Government SATCOM terminals.

“Our customers presented us with the challenge of enabling a single terminal to be used on a variety of current and emerging satellite network architectures.”

“Satellite industry customers need a well-designed approach to accommodate the changing expectations and resources available to them. Our new wideband K_a -band BUCs enable customers to design flexible terminals that can operate on traditional GEO satellites, existing MEO networks and the much-anticipated LEO constellations that are now in the early stages of deployment,” said Francis Auricchio, president and CEO of Mission Microwave.

Additional product announcements from the company include the introduction of a 150 W X-band BUC in the Javelin package. This rounds out the Javelin product family with a common mechanical and control interface for the 150 W X-band, the 100 Watt K_u -band and the 50/100 W K_a -Band.

Each Javelin BUC weighs under 11 pounds and is ideal for multi-mission terminal designs needing high power tri-band capability.

At the SATELLITE 2019 event Mission

exhibited its complete product line of high power X, K_u and K_a Band amplifiers and BUCs and will have example terminal designs from key industry partners on display.

Mission products were on display across



the venue, incorporated into many industry-leading products from top-tier customers' mobile and transportable terminals.

Wolfspeed

A CREE COMPANY

Transforming Power with Industry-Leading SiC Expertise and Capacity

Wolfspeed is here to help you achieve the highest efficiency and power density for your system with SiC.

We have an expanded assortment of SiC bare die, discretes and modules to help solve your system design challenges.

Visit us at PCIM 2019 in Stand 9-240 to see our reference designs and talk with our technical experts.



For a complete listing of our PCIM product launches, demos and presentations, visit wolfspeed.com/pcim-cs



Ahead of the pack

EPC's Alex Lidow believes his GaN devices now beat silicon on performance and price, reports Rebecca Pool

FOR EPC chief executive, Alex Lidow, this year's PCIM Europe 2019 has been all about applications. Presenting myriad enhanced-mode GaN FETs and ICs in end-products, the company is making a big play for 48 V DC-DC power conversion in advanced computing and automotives.

"The market that we are making a full-frontal attack on, is silicon at 48 V input," he says. "We can get higher performance from GaN at a lower cost and with less design time... just think what it's going to be like in a few years."

"It's been a race and GaN has always been in front on performance but not on price," he adds. "But now we're in front on performance and price, and we're also accelerating; silicon's stuck in the mud."

In recent years, EPC has been introducing ever-

smaller, cheaper and higher-performing chips. Recently delivering 100 V eGaN FETs for 48 V DC-DC conversion in servers and automotives, as well as automotive-qualified 80 V eGaN FETs for lidar applications in autonomous vehicles, Lidow says device costs now rival those of silicon chips.

"We've shrunk the die so much that, for the same ratings, we price our products at or below silicon [prices]," he says. "Price comparisons with silicon MOSFETs at a range of performance levels show that whether we're at low or high volumes, we're priced at the below average point."

"And of course, the performance of GaN devices is so much superior to silicon MOSFETs at 48 V," he adds. "So our devices are smaller and more efficient than silicon MOSFETs, yet the same price, so what's not to like?"

Market moves

With market penetration a priority, Lidow has his sights set on data-centre and automotive applications. Following the success of the Open Compute Project – an organisation that shares designs of data-centre products – engineers are moving to 48 V rack-level power distribution systems to boost energy efficiency of the latest high-performance computers and servers for data centres.

“We have this movement towards 48 V... and today the preferred solutions are LLC-converter and buck converter [power conversion] topologies,” highlights Lidow. “And here, I will say with all due modesty, our products have swept all the new designs. Almost all of this is coming out of Asia, and it’s a big deal for us.”

Meanwhile, the automotive industry continues its shift from 12 V to 48 V electrical distribution buses, particularly in mild hybrid vehicles, to handle power steering, power brakes, air conditioning, suspension, high-intensity headlamps, start-stop systems and more. What’s more, new applications such as autonomous vehicles equipped with sensors, lidar and radar are emerging.

As such, Tier 1 automotive suppliers are busy developing 48 V electrical systems, as well as bi-directional systems to support both 48 V and 12 V legacy accessories.

“Given all of this, automotives is huge for us,” says Lidow. “For example, the minute you go to even a mild hybrid vehicle, you have more electrical components drawing more and more power.”

“We have 80 V and 100 V FETs auto-qualified for DC to DC, lidar and headlamp applications and we’re also designing into infotainment and radar systems,” he adds. “There’s a heavy design effort here right now and the market will really be starting to reach volume [production] in 2021.”

Indeed, for the EPC chief executive, the real action for GaN still lies at 400 V and lower, where the semiconductor’s high frequency and switching speeds are imperative for applications such as lidar. “[Compared to lower voltages], the 600 V GaN market is a crowded field right now and has key vulnerabilities,” he says. “For starters, it’s not such a performance-sensitive market, and both silicon and silicon carbide are also gunning for that 600 V node.”

At the same time, he highlights how remote control electronics are enabling the use of multi-level converters to hit the higher voltages. Case-in-point, at this year’s PCIM, EPC demonstrated a 400 V input power factor correction circuit made from 200 V devices stacked in series.

“In this way you can pick up the higher power density at a lower cost,” he says. “So at these higher voltages,

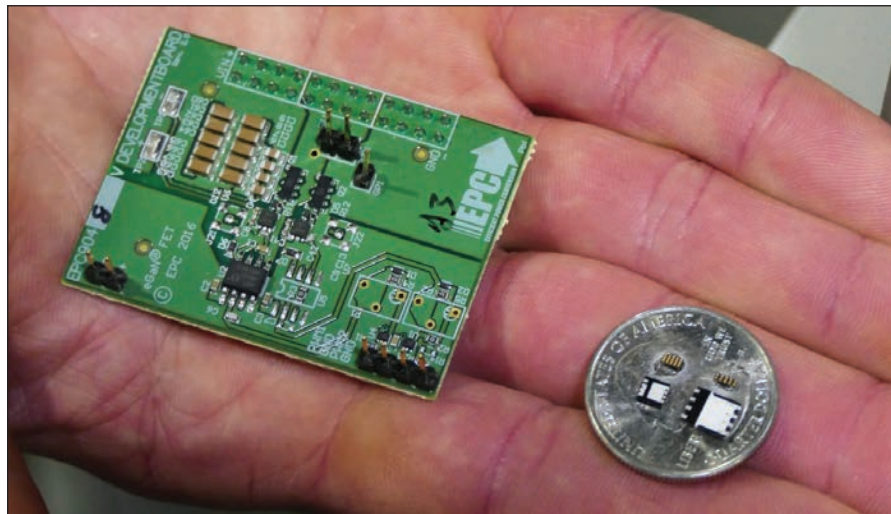

the threats for GaN are coming in from all directions... I’m not saying this isn’t a valid market but it’s going to be a difficult slog.”

So where next for EPC and GaN? In short, integration and monolithic GaN ICs.

In March this year, EPC revealed a monolithic half-bridge GaN transistor with level shifters and drivers integrated onto the chip. The transistors are currently with alpha-customers and Lidow expects to launch devices towards the end of this Summer.

What’s more, he believes this latest IC marks the beginning of a new era for GaN power components.

“Today we see power components as transistors or diodes but I predict this [monolithic device] will redefine what a power components is,” he says. “And I will also say that in five years, I doubt we will be launching discrete GaN transistors at all; instead we’ll be launching power products that have features and functions.”

A 200 V GaN FET from EPC: these devices are now said to outperform comparable silicon MOSFETs on size, power losses, power density as well as cost.



Exagan reaches out to global markets

With its second Power Solutions Centre launched, Exagan is ready to bring GaN-on-silicon devices to the masses, reports Rebecca Pool.

RECENTLY, GaN-on-silicon device pioneer, Exagan, has been investing a great deal in its infrastructure. This May, while attending PCIM Europe 2019, it revealed that it will be opening a Power Solutions Centre in Toulouse, France, to advance its GaN portfolio.

The latest Centre follows the launch of Exagan's first applications centre in Taiwan later last year, and accompanies established epitaxial manufacturing facility in Grenoble, France. Crucially, it comes at a time when the supplier is keen to demonstrate the performance of its 650 V 'G-FET' power transistors in power chargers, power factor correction circuits and more.

"With our new Toulouse Center we will scale up activities," says Frédéric Dupont, president and chief executive of Exagan. "We have a new building and facility with an application development area and I am looking to extend the team, starting with new application engineers and field application engineers."

As part of the latest Centre, Exagan is working in partnership with CEA Tech and harnessing the research unit's cutting-edge GaN-on-silicon epitaxy equipment for producing diodes and HEMTs. "We have access to this very nice power electronics platform and now have the critical [mass] of expertise, people and equipment to really grow activities here," says Dupont. A critical part of these activities will be



Inset: Exagan's Power Solutions Center in Toulouse, France.

With its G-FET, a key focus for Exagan right now is electric vehicle applications including on-board chargers and fast-charging stations, which according to Dupont, demand less integration.

“Our strategy is to use the same platform for consumer and, in the future, automotive markets – this is at 200 mm, and is established and proven for manufacturing,” he says.

Fast charging is a further important market for the G-FET, with the device already demonstrated in 65 W USB PD 3.0 power chargers. Meanwhile, the G-DRIVE is set to support power factor correction circuits ranging from 300 W to 1.5 kW for next-generation data centres.

Dupont now intends to drive GaN adoption in these markets by delivering a robust product, working with partners to ensure the supply chain is in place and, of course, providing the necessary applications support via its new centers.

“I think there has been a gap in the market, from having the support to ensuring reliability in the field, but we can really provide solutions,” he says.

“So we have started with Taiwan and Toulouse, and if our customers want to know about GaN, the technology, the product, the implementation, and get support for a solution in that application, then they can come to us,” he adds. “We control the technology, manufacturing, reliability and we also have all the expertise for the integration and applications.”

But what about the ever-looming threat of SiC? Cree recently revealed plans to invest a might \$1 billion in SiC capacity, a huge boon for markets adopting devices based on this rival compound semiconductor.

Dupont isn't flustered. From word go, the chief executive has emphasised that G-FET power transistors can be fabricated in existing 200 mm CMOS wafer fabs, delivering clear cost benefits while easing manufacturing scalability and supply.

“GaN is an open platform in the sense that we are using CMOS fabs... and we can scale very quickly to high volumes,” says Dupont. “In contrast, I see SiC as a much more closed platform; it's a specific material with supply limitations, and also demands high temperature and complex [fabrication] processes with specific equipment and manufacturing lines.”

“Where silicon is good enough, then fine, silicon will stay, he adds. “But when GaN can provide a boost to silicon in an application, then GaN will always get there. SiC is a very different world.”

to hone new GaN architectures while raising power conversion efficiencies in existing topologies.

According to Dupont, his company's clear focus right now is on the market and enhancing current topologies, but as he adds: “We will also be developing simpler, more efficient and powerful architectures and really looking at the possibilities that can be achieved with GaN.”

From device to system

While at PCIM, Exagan was showcasing its 650 V GaN-on-silicon power transistor, G-FET, as well as its integrated driver and transistor switching system, G-DRIVE. According to Dupont, the GFET combines GaN and silicon in a simple cascode configuration, and can be used with silicon drivers for easier integration.

In contrast, the G-DRIVE system features an integrated driver and transistor in a single package. And as Dupont says: “This is a more complex product but some applications do need a more integrated solution... and we are now sampling to customers.”

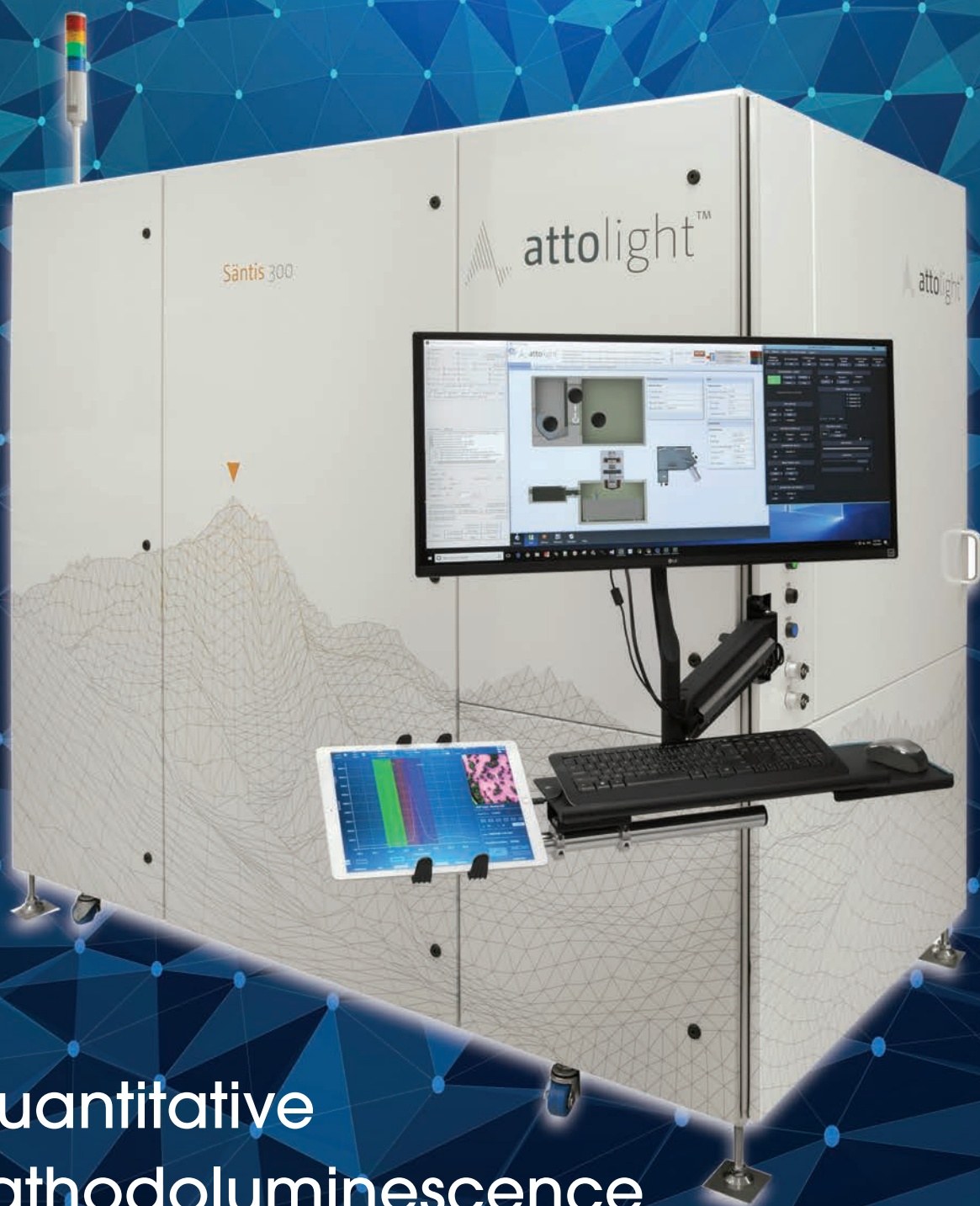

Quantitative cathodoluminescence streamlines chip production

Cathodoluminescence offers a quick, non-invasive approach to determining alloy compositions, exposing defects and uncovering surface contamination

**BY CHRISTIAN MONACHON AND SYLVAIN MUCKENHIRN FROM ATTOLIGHT
AND HASTI MAJIDI AND CHRIS FRANCE FROM ALTA DEVICES**

ALL COMPOUND SEMICONDUCTOR chipmakers, from the producers of LEDs, lasers and solar cells to the makers of power and RF devices, need to characterize their material. It is an essential step in the production process that can expose and identify any imperfections in epiwafers, and may save money and reputation, by avoiding the production of devices with dubious characteristics.

Cathodoluminescence is one of the many techniques that may be used to characterise epiwafers. It involves directing a beam of electrons at the surface of a wafer, and collecting, in parallel, secondary electrons and an optical signature. Data extracted from these distinct signals are complementary and offer much insight into the characteristics of the material. For example, imaging cathodoluminescence intensity highlights both buried and surface defects, and the latter can be distinguished from the former using a secondary electron image taken in parallel (see Figure 1).

At Attolight of Lausanne, Switzerland, engineers have developed a portfolio of cathodoluminescence instruments, including Sântis 300, an instrument capable of full-wafer mapping (for details of this tool, and its capabilities, see *Capabilities and strengths of Sântis 300*). Read on to discover how this tool has been used by GaAs solar cell producer Alta Devices to undertake three particular tasks: to speed and trim the costs associated with developing the process for producing AlGaAs layers with well-defined compositions; to detect defects detrimental to device performance; and to expose surface

contamination. Note, moreover, that Alta Devices also use cathodoluminescence for new layer design development.

Characterising composition

To optimise the performance of GaAs solar cells, makers of these devices must produce homogeneous layers of AlGaAs alloys with a composition that is very close to the target value. Success in this endeavour often involves measuring the composition of AlGaAs epilayers with Auger electron spectroscopy, but cathodoluminescence offers a superior alternative.

One of the merits, benefitting the engineers at Alta Devices, is the substantial cost saving associated with preparing a reactor for its initial production of solar cells. Prior to the growth of this photovoltaic structure, calibration runs are required, with typically five cycles needed to tune homogeneity, and a further five to tune the ratio of aluminium to gallium in the AlGaAs epilayers.

Savings of around \$50,000 are realised by carrying out this initial tuning with cathodoluminescence, rather than the more common approach, Auger electron spectroscopy. The reduced expenditure partly stems from making the measurement in-house, rather than shipping a sample to a specialist that will take several days to provide a result. In addition, as Auger electron spectroscopy is a destructive technique, a cost comes from being unable to re-use the base wafer.

Another advantage that cathodoluminescence has over Auger electron spectroscopy is that it

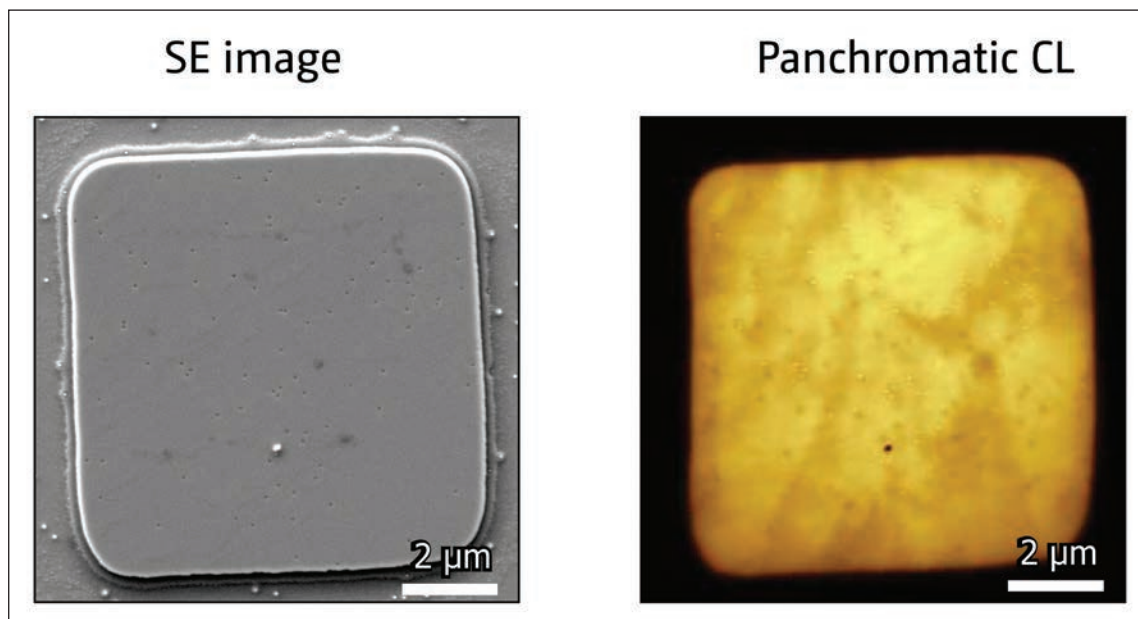

Figure 1. The Attolight Sântis 300 can provide scanning electron (SE) and panchromatic cathodoluminescence (CL) images. Shown here are 7 µm by 7 µm images of a microLED. The largest dark spot is attributed to a speck of dust, visible in the scanning electron image. Several types of buried defects can be identified in the cathodoluminescence map.

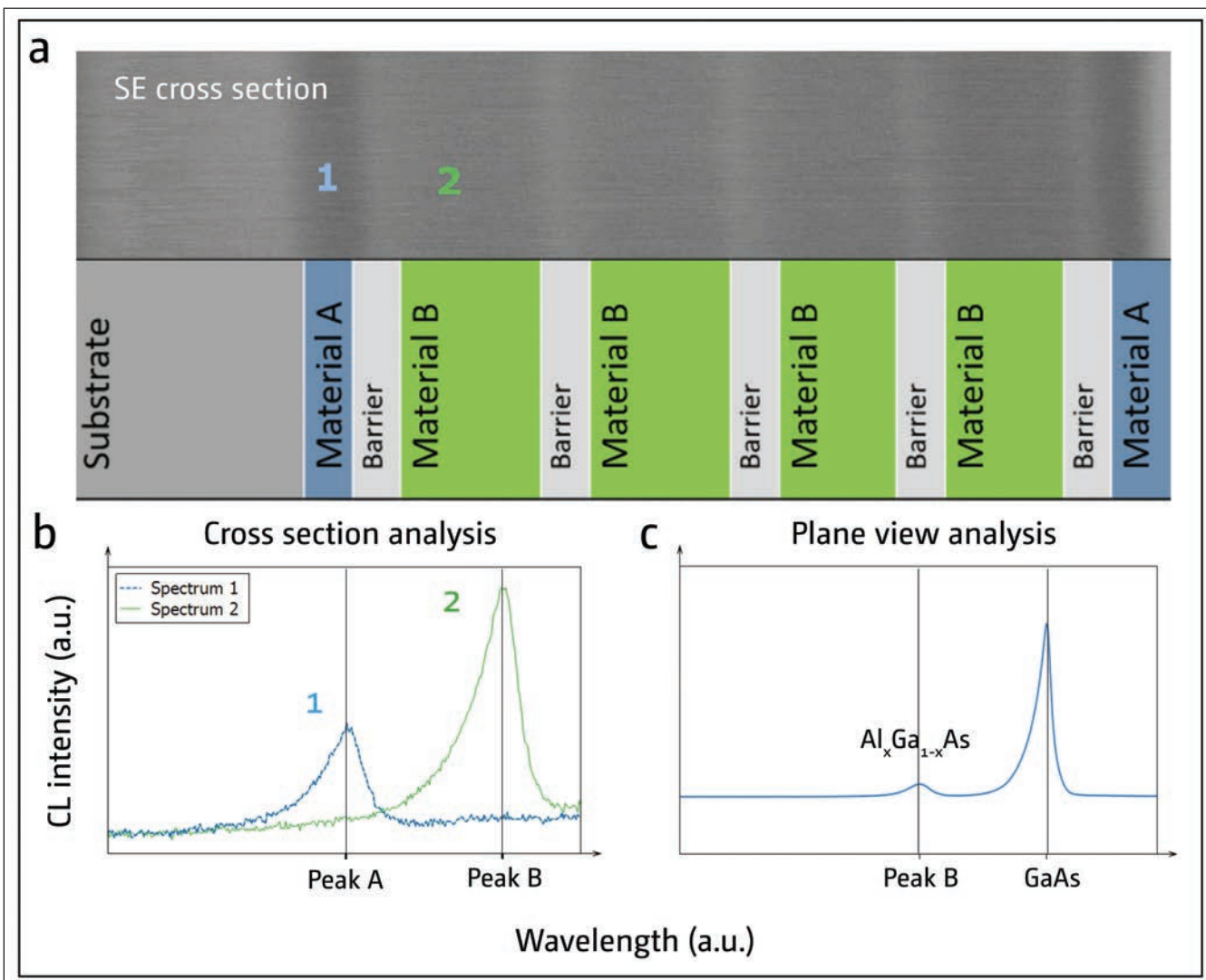

Figure 2. (top) Cross-sectional scanning-electron imaging of a multilayer $\text{Al}_x\text{Ga}_{1-x}\text{As}$ stack together with a diagram of the structure. The sample is used for the initial cathodoluminescence calibration with respect to Auger electron spectroscopy. (bottom left) cathodoluminescence spectra extracted from material A and B, exhibiting distinct spectral features. (c) application of the obtained calibration in top view, production mode, to obtain a composition for material B.

offers greater insight into the characteristics of the wafer. Whether undertaking initial tuning, quality control or R&D, cathodoluminescence provides a faster turnaround and better statistics. Operating in an automated step and repeat mode, this technique can determine alloy composition at more than 120 points per wafer in less than 5 minutes. In comparison, it takes an hour to measure one point on a wafer by Auger electron spectroscopy.

Cathodoluminescence is also a very powerful tool in a production environment. As it is non-contact, there is no need to scrap any base material. Instead, samples can be returned to the production batch after they have been inspected. Higher production yields are also possible – measurements typically take much less than 30 minutes, so if there is a problem with the growth process, this should become apparent before a second out-of-specification run begins.

Identifying sub-surface defects...

When producing GaAs solar cells – or, for that matter, power and RF electronic devices – a major concern is the class of defect that can cause a short circuit between the active layers. This type of defect is hard to spot, as it is not visible by either scanning electron microscopy, optical microscopy or atomic force microscopy.

Prior to the availability of cathodoluminescence, defects were identified by an electron beam induced current. However, this measurement has to be carried out on the final device, resulting in a time delay before the process can be adjusted. With cathodoluminescence, this time is divided by ten, because the very same defects can be identified right after the epi process. This significantly speeds the development process and produces material with better properties – and ultimately a better average

device quality. The non-contact, non-destructive nature of cathodoluminescence also pays dividends. If the material is good, production steps can proceed on analysed samples.

Obviously, a non-destructive technique doesn't save money when epiwafers are poor, and need to be scrapped. However, the speed of this technique enables a saving associated with avoiding unnecessary processing on sub-standard wafers.

Yet another merit of cathodoluminescence is the greater insight it offers, compared with the electron beam induced current technique. This aids root cause identification, because with cathodoluminescence, the layer containing the crystalline defect can be identified by its detailed spectral signature.

... and surface contamination

When surface contaminants are on the epiwafers, they tend to have a significant impact on surface luminescence and absorption. Consequently, there

is an opportunity to quantify their relative density by cathodoluminescence. This is particularly useful with photonic materials, as contaminants can drag down device efficiency.

The strengths of cathodoluminescence – it is able to expose surface contaminants, uncover defects that can cause a short circuit, and provide a quick, insightful approach to determining alloy compositions – are sure to spur interest in this tool. However, like all inspection instruments, how much value it offers will be debated by potential customers, who will try to consider its capability with new process technologies.

Intuitively, inspection and metrology tools have always been put into the 'non-value-added' bin. That's never the case with process tools, as they can modify production steps, making devices cheaper, better, or possible both. Over the past few decades this stance is softening, with the ratio of investment in metrology tools to process tools climbing from around 2 percent to 10 percent, according to VLSI Research. This is a

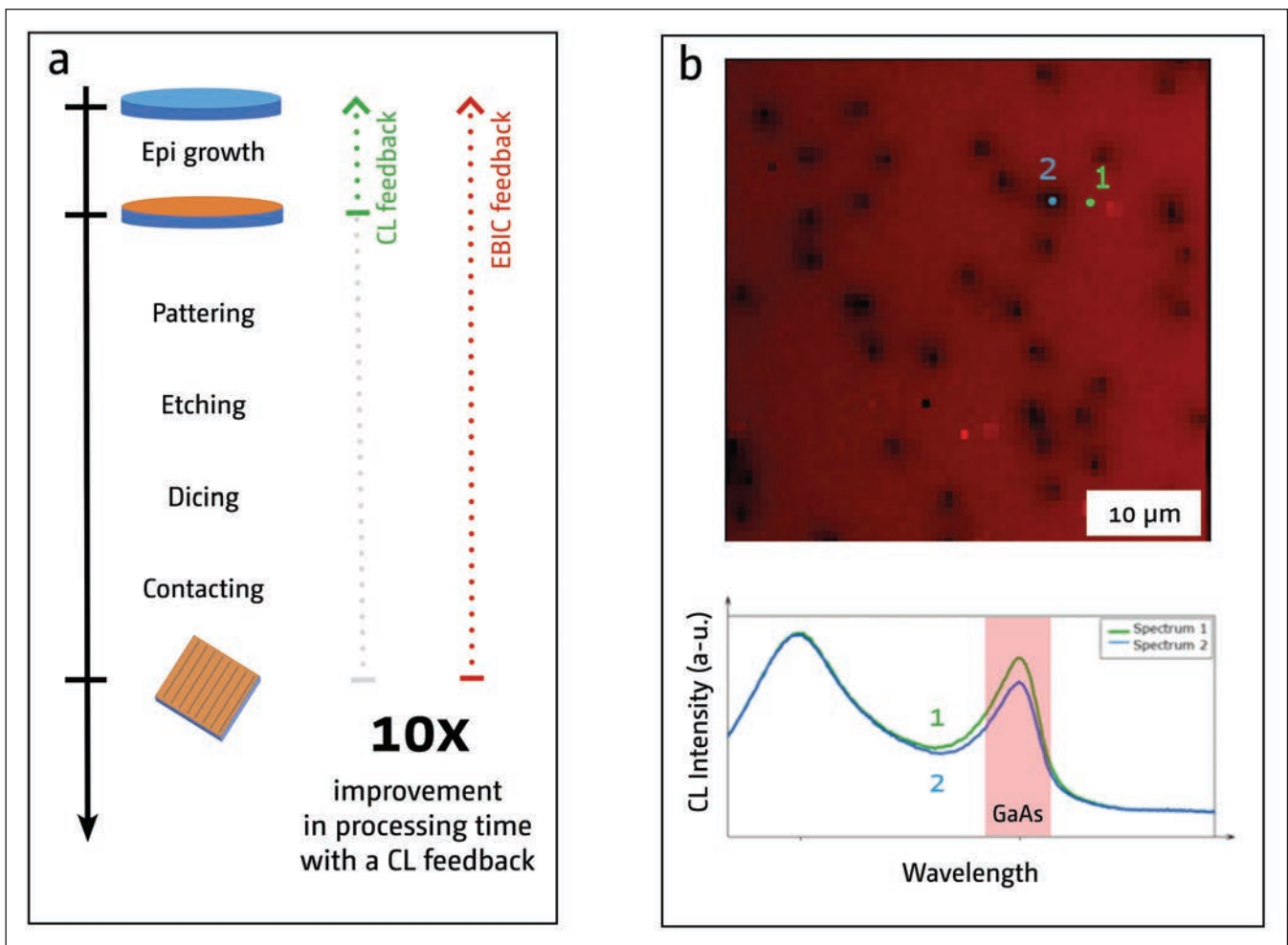

Figure 3. (left) Identifying defects with cathodoluminescence, rather than the electron beam induced current technique, trimmed the turnaround time for defect density determination and process adjustments by a factor of ten. (top right) cathodoluminescence imaging, centred on the GaAs band edge emission, exposes crystalline defects. Comparing points 1 and 2 with spectral scans (see bottom right), shows that only the GaAs peak suffers a variation. This suggests that the defect spotted at point 2 is actually in the GaAs layer of the stack, not in the other layer emitting the light in the peak to the left of it.

testament to the critical impact provided by the right inspection and metrology tools.

For the compound semiconductor chipmakers, there is tremendous value in managing point and line defects and measuring and controlling the composition of alloys. The merits of this, highlighted by the efforts of GaAs solar cell maker Alta Devices and detailed in this article, champion the virtues of cathodoluminescence. They are not limited to measuring GaAs solar cells, but extend to GaAs photonics and all compound semiconductor devices,

and can be summed up as three key strengths. They are: a faster turnaround in R&D and process development, speeding the time to market for new technologies; a non-invasive nature, which enables more frequent process control with no impact on production, while avoiding scrapping analysed samples and slashing the cost of metrology; and improved process metrology statistics, enabling tighter process control and directly impacting production quality, so a greater proportion of devices go into top-selling bins. All these assets make a meaningful impact by improving a fab's balance sheet.

Capabilities and strengths of Sântis 300

ATTOLIGHT provides instruments that offer efficient quantitative cathodoluminescence, including the Sântis 300 full-wafer instrument. It is a capability that comes from the aberration-corrected optical objective, which is directly integrated inside the electron objective lens. One of the merits of this design is that for optical alignment, the approach is just the same as it is in a regular optical microscope, with the height of the sample adjusted until it is in focus. This enables simple, rapid and reproducible automated optical alignment.

The other significant strength of this particular tool is that no photons are lost over a 300 μm -diameter field of view, so no further adjustment is needed. This ensures reproducibility within 1 percent for the entire field of view.

The capabilities of the Sântis 300 hardware are exploited by several software features. They provide a range of measurements, from fast overviews, to slow imaging with nanometre-scale resolution. Operating in its manual mode, the tool combines scanning electron microscopy with cathodoluminescence spectroscopy. Beyond this, the instrument can provide wafer-edge recognition and alignment;

column self-alignment and calibration; optical and electronic performance testing; and wafer bow measurement.

To ensure that the Sântis 300 accommodates a very wide variety of needs, it features three distinct automated acquisition modes:

- Step and repeat, performing high resolution analysis – for instance, down to 40 nm for cathodoluminescence and 10 nm for scanning electrons on GaN – on a select number of user-specified coordinates.
- Full wafer brush, a patent-pending process that allowing a spectrally-resolved scan of a 6-inch wafer in less than 10 minutes, for a 300 μm resolution.
- Across wafer pixel, a patent-pending mode of operation that has a resolution down to 250 nm, and produces an intensity-only image of the full wafer or key parts of it. This allows a full 6-inch wafer diagnostic in little more than two hours, for a resolution of just 1 μm .

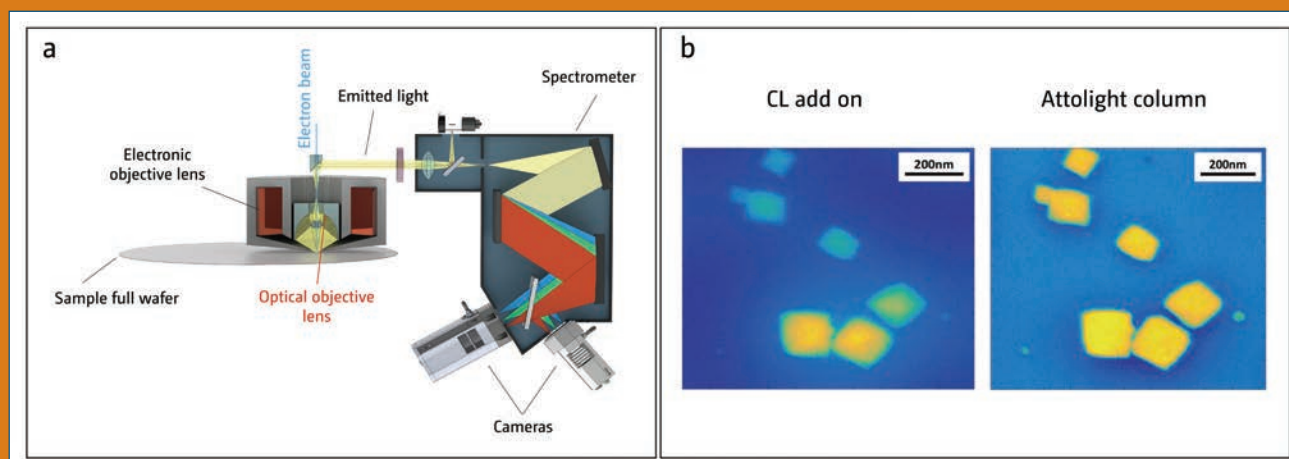

(a) The detection path in Attolight's proprietary electron column features an aberration-corrected optical objective that is directly integrated into the electronic objective lens. (b) A key advantage of the aberration-corrected objective is that it ensures perfect homogeneity of the signal collected. This is illustrated in the image of the particles and the blue background, produced courtesy of P. Maurer and S. Chu, Stanford University.



The global leader in
wafer outsourcing

www.iqep.com



- World leading technology
- Complete materials range
- MOCVD, MBE & CVD platforms
- Advanced substrates
- Multiple, manufacturing sites
(Europe, Asia, USA)
- Advanced R&D facilities

Enabling advanced technologies

Offering the Industry's Broadest Product Portfolio



Wireless



Photonics

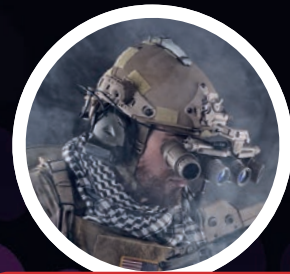

Infrared



Solar



CMOS++



Power

CREE and INFINEON BUCK THE TREND

The share prices of many compound semiconductor companies have taken a battering over the last twelve months. But that's not the case for Cree and Finisar – their valuations are soaring.

BY RICHARD STEVENSON

IN THE RUN-UP to last New Year, stories of turmoil on the stock markets grabbed the headlines. The technology-focused NASDAQ and the FTSE 100 were caught in a bear market, and would exit 2019 at a lower value than they started.

Since the start of this year, there has been something of a recovery. Stock markets are up considerably, recovering to near the peaks experienced last summer. So while the last twelve months have not been a great time for shareowners, many of them will not have suffered substantial losses, and the canny ones may even have made a small profit.

Unfortunately, if your portfolio of shares draws heavily on the compound semiconductor industry, it's odds-on that your investment will have fallen, as many of these firms have struggled. But if you have backed the right horses, you could have done very well. Only four of the 16 firms on our Shareprice Leaderboard (see p. 27) have had a positive last 12 months, but two of them have done exceptionally well over this timeframe. Cree has led the way – although its shares bobbed up and down in 2018, they have climbed throughout this year, to increase by over 65 percent compared with the end of April last year. And taking second place on the Leaderboard is Finisar, with shares up by just over 50 percent over the last 12 months.

Cree's superb transition

Cree's success has to be credited to its CEO, Greg Lowe, who has shifted the focus of the company. Once renowned for industry-leading LEDs and the development of a lighting business, its future now lies

in the power electronics and RF sectors. Under Lowe's leadership, capacity in these areas has increased, while margins have been maintained.

The latest significant move in this transformation came this March, when Cree announced that it would be selling its Lighting Business to Ideal Industries for \$310 million, including an upfront cash payment of \$225 million.

While updating investors on the details of this sales and its significance, Lowe revealed how far Cree had come in last 18 months or so to make this company a "semiconductor powerhouse" in SiC and GaN technologies.

"Over that timeframe, we have grown Wolfspeed by 100 percent, acquired the RF Infineon Power business, more than doubled our manufacturing capacity of SiC materials, and signed long-term supply agreements, which are, in aggregate, in excess of \$500 million dollars," remarked Lowe.

He pointed out that the company now has a faster growth profile than before, alongside higher margins and a cash balance approaching \$1 billion.



This story of success is echoed in the most recent quarterly earnings, provided on 30 January 2019. Second-quarter results showed that the Wolfspeed division, associated with RF and power devices and SiC substrates, operated at a gross margin of nearly 48 percent, while LED products had a gross margin of 30 percent, and that figure for Lighting Products was just below 26 percent. So, based on gross margins, selling off the Light Products unit makes much sense.

Right now, the LED Products and the Wolfspeed divisions are generating similar sales. But Wolfspeed will soon take the lion's share. Based on figures for the second fiscal quarter, its sales grew by 92 percent year-over-year to \$135 million. Although that has been aided by the acquisition of Infineon's Power business,

even when that is taken out of the equation, revenue has rocketed by 50 percent. In comparison, LED Products netted \$145 million, down 5 percent year-on-year and 1 percent sequentially.

Lowe believes that the company's technologies lie at the forefront of the automotive industry's transition to zero-emission electric vehicles, the telecommunication industry's move to faster 5G networks, and the continued ramp-up of LEDs for speciality light applications, such as the light sources for the Valeo Picture Beam – it is a high-definition vehicle lighting product that combines road marking with high-performance low-beam and high-beam functions.

“Within the electric vehicle market, the interest in



silicon carbide is extremely high, because the value proposition is so strong,” said Lowe, when speaking to investors during the call that discussed second quarter earnings. “Utilising silicon carbide saves space, reduces cooling requirements, and allows for a smaller, lower-cost battery. These benefits far outweigh the incremental cost.”

Another opportunity for SiC lies in electric vehicle charging. Owners want the time to charge their vehicles to be as short as possible, but this requires a quicker transfer of energy. “They’re going to do that with higher voltages and that’s going to be a natural fit for silicon carbide,” said Lowe.

During the call, Lowe argued that the wireless telecom market is moving towards GaN, because this enables faster 4G and the transition to 5G, thanks to its wider bandwidth, higher frequency and higher efficiency. “The outlook is very promising, and we are in the process of adding GaN production capacity to meet the increasing demand that we’re seeing.”

Over the next 24 months, Cree will re-double the production capacity for its SiC and GaN products. This latest phase of build-out is aided by the long-term wafer supply agreements. So far, these have been signed by Infineon, STMicroelectronics, and a third, undisclosed firm. Additional contracts may follow. “I think we’re not done yet,” said Lowe. “I would also say that the more we get into conversations, the more excitement there is about doing these longer term deals, because people are very concerned about having the capacity to meet their plans.”

As well as an increase in sales from the Wolfspeed unit, margins from this unit are expected to rise, to eventually exceeds 50 percent. Such a high level of profitability, along with around \$1 billion in cash, should assure Cree of a very bright future.

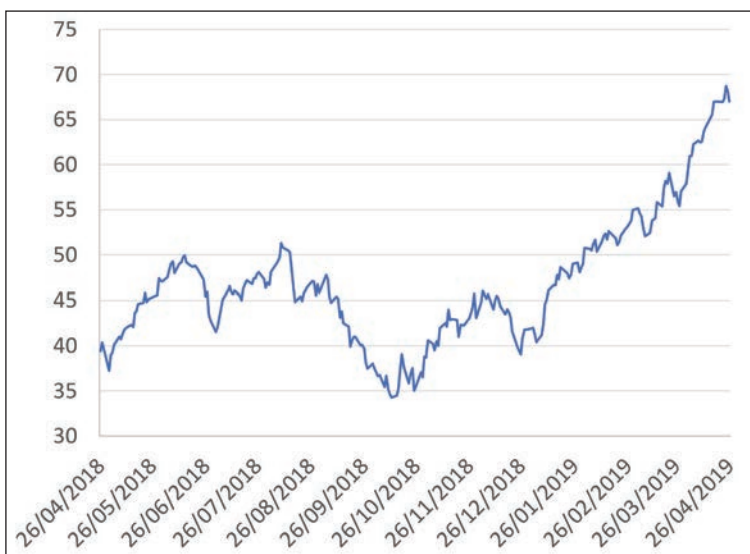

The value of Cree’s shares has climbed substantially over the last six months.

Finisar’s fortunes

Second on our Leaderboard is Finisar, a manufacturer of components and sub-systems to networking equipment manufacturers, datacentre operators, telecom server providers, makers of consumer electronics and automotive companies. In general, Finisar’s share price has climbed steadily over the last 12 months, but it did take a substantial leap in November 2018, when it was announced that the company would be acquired by II-VI this summer.

II-VI holds Finisar in very high regard, and believes that the deal will enable the new entity to realise annual revenues of \$2.5 billion. Increases in scale and efficiency after the merger are anticipated to lead to cost savings of \$150 million per year.

Speaking to investors at the time of the announcement of the deal, Finisar CEO Michael Hurlston said that the merger should accelerate growth across the board. In addition, he thought that the terms of the transaction were good for Finisar shareholders.

“It provides immediate cash value, while providing the opportunity to participate in the significant upside potential of our combined organisation once the transaction is completed.”

II-VI agreed to buy shares in Finisar at \$26.00, a premium of 38 percent, according to the closing price prior to the announcement. Once the deal goes through, Finisar’s shareholders will own about a third of the combined company.

While the market considered this a great deal for Finisar, with its share price shooting up from around \$17 to \$21, they thought it wasn’t ideal for II-VI. Shares in this company plummeted by around 20 percent.

Since the announcement of the acquisition, Finisar’s share price has fallen slightly towards the end of the year, before steadily climbing in 2019. This reflects the solid performance of the company. For example, results for the third fiscal quarter 2019, announced at the end of February, show a modest increase in revenue – it is up \$2.2 million, or 0.7 percent, compared to the previous quarter – due to greater sales of wavelength-selective switches and VCSEL arrays for 3D applications. Gross margin also increased sequentially, rising by 2 percent. This has been attributed to a favourable product mix and a continued focus on reducing manufacturing overhead.

Lumentum’s recovery

The third-placed company on the Leaderboard is Lumentum, best known for its VCSEL products. Its shares have been up and down over the last 12 months, but thanks to a recent steady climb, have gained nearly 20 percent since last April. That’s a good recovery, given the nosedive in early November, when shares plummeted from almost

Compound Semiconductor Shareprice Leaderboard						
Rank	Company	Ticker	Share value, April 27, 2018 (\$)	Share value, April 27, 2019 (\$)	% appreciation	Change in Rank
1	Cree	CREE	40.37	67.00	66.0	+2
2	Finisar	FNSR	15.68	23.95	52.7	+12
3	Lumentum	LITE	52.15	60.02	15.1	+3
4	Rubicon	RBCN	6.76	7.62	12.7	+7
5	NASDAQ composite	IXIC	7195.52	8100.28	12.6	+2
6	Qorvo	QRVO	68.59	73.85	7.7	+3
7	Skyworks	SWKS	87.77	87.37	-0.5	+6
8	II-VI	IIVI	39.80	38.92	-2.2	n/a
9	WIN Semiconductor (Taipei)	3015.TWO	7.33*	7.05*	-3.8	n/a
10	AXT	AXTI	6.35	5.50	-13.4	+2
11	Emcore	EMKR	4.75	4.03	-15.2	+4
12	IPG Photonics	IPGP	215.70	173.08	-19.8	-8
13	IQE (London)	IQE	133.9*	98.9*	-26.1	-8
14	Veeco	VECO	16.85	12.04	-28.5	+2
15	Aixtron (Frankfurt)	AIX	15.78*	11.15*	-29.3	-14
16	Riber (Paris)	RIB	4.21*	1.82*	-56.8	-14
17	Infinera	INFN	11.81	4.41	-62.7	-9

* Converted to dollars using the exchange rates on 27 April of 1 EURO = 1.11569 USD, 1 GBP = 1.29333 USD and 1 TWD = 0.0323567

\$60 to around \$37, due to a fall in orders from a major customer. Although not named, it is widely assumed that the reduced demand came from Apple, which accounts for around 30 percent of sales – it uses Lumentum’s VCSELs in its facial recognition systems in its premium smartphones.

The loss off business forced Lumentum to update its quarterly guidance a little more than a week after it gave its first forecast. Initially predicted to be between \$ 405 million and \$430 million, sales would now be around \$70 million lower.

The figures for that quarter came out this February. Revenue from the existing business met with guidance, with total sales hitting \$374 million, due to a \$30 million contribution from Oclaro, acquired by Lumentum on 10 December 2018.

Speaking to investors on 5 February, in a call to discuss earnings for the second fiscal quarter 2019, Lumentum’s CEO, Alan Lowe, explained the rationale for the acquisition: “It gives us a differentiated leadership position across a range of photonic chips on which the datacom, wireless, and access market is critically relied. This creates new avenues to profitable growth through meaningful chip sales and more cost-competitive transceivers.”

Lowe believes that this acquisition, which equips Lumentum with InP technology, could be the first of many such moves in the optical communications industry. In his view, there has been a long-term need for consolidation.

Cost savings should result from the acquisition. During the call, company interim CFO Christopher Coldron told investors that within 12 to 24 months savings could be in excess of \$60 million per year – and even in just a few months, they were worth around \$10 million.

In the Smartphone sector, Lumentum is not tied to Apple, but also shipping to makers of Android products. “We continue to make excellent progress with additional Android customers and additional new design wins. The market for laser-based sensing is still in its infancy,” remarked Lowe.

He is very upbeat about the long-term opportunities in this sector, believing that the company’s products could be used to enhance security, safety and new functionality in billions of electronic devices. “The seeds for this long-term market opportunity continue to be planted.”

Another promising product within the portfolio is the fibre laser. Lumentum realised record revenue for its kilowatt-class fibre lasers, with sales up 12 percent sequentially, and up a whopping 133 percent compared to the equivalent quarter of the previous year.

The growth in sales of electric vehicles is helping Cree to increase its sales of SiC power devices.



Guidance for the third fiscal quarter is for an increase in revenue to \$420 million to \$440 million, and operating margins slightly lower, at between 16 percent and 18 percent.

Infinera's slump

At the bottom of the Leaderboard is Infinera. It has had a torrid twelve months, with the share price dropping from around \$12 to nearly one-third of this value. The decline has been steady, with the trade war between the US and China contributing to the company's woes.

Against a backdrop of a steady decline, there have been two sharp drops in May and November 2018, when the company reported its first and third fiscal quarter results for 2018. The 20 percent drop in share price associated with the first quarter results on 9 May did not result from missing guidance figures. Quarterly sales of \$203 million were towards the top of guidance, and gross margins exceeded expectations by 2 percent.

However, the sharp drop in valuation may have reflected the guidance given at that time, with expectations of only a slight increase in sales, and no gain in gross margin.

When the earnings came out for the third fiscal

quarter, the share price fell from just over \$6 to below \$4.50. Revenue and gross margins were within guidance, but towards the bottom end.

In the most recent fiscal quarters, revenue is far higher, due to the acquisition of Coriant, bought on 1 October 2018. That purchase helped sales to swell to \$332 million for the fourth fiscal quarter, and although integrating the new company has hit gross margin, it is expected to recover.

Speaking to investors on 21 February, 2019, during a call detailing fourth fiscal quarter results, company leaders spoke very positively about the acquisition of Coriant. CFO Brad Feller explained that by enlarging the company, it had a stronger negotiating position with suppliers, and had been able to reduce purchase prices by up to 35 percent. The bottom line will also benefit from better gross margins, with an increase of over 10 percent targeted by 2021.

If significant strides towards this goal are met by April 2020, it would be surprising to see Infinera footing the table this time next year. And should they return to the share price of \$12 or so, of late April 2018, that would give them an appreciation of 200 percent, a figure surely high enough to top the table.

Can they do that? Stay tuned to find out.

SUBMIT YOUR LAB & FAB ARTICLE

Research is the foundation for the growth of the compound semiconductor industry.

If you want to highlight the important breakthroughs that you make, submit your latest research stories to:

Richard.Stevenson@angelbc.com

It is imperative that Compound Semiconductor remains a timely resource for this industry, so we are only interested in highlighting very recent work reported in academic papers.

Therefore, please only consider writing a short piece highlighting your work if you have a journal paper that has been accepted and about to appear in press, or a paper that has been published within the last month.



www.compoundsemiconductor.net



Wafer cathodoluminescence for production statistical process control

Wafer incoming Blank wafer control Crystalline growth processes

- Non-destructive
- Nanometer level
- Buried defects quantification
- Crystal defects quantification
- Doping uniformity
- Strain
- Optical spectrum signature

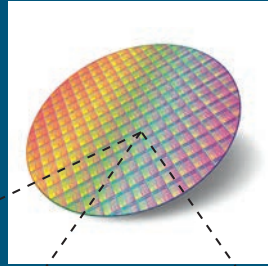

Power & RF (GaN + SiC) HEMT Nanoscale GaN HEMT layer composition & strain distribution

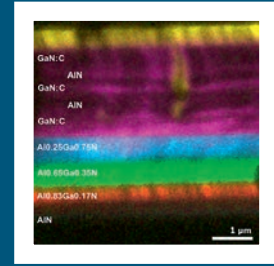
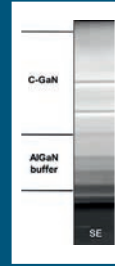

SEM

Cross section HEMT

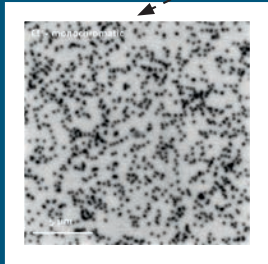

CL - Monochromatic

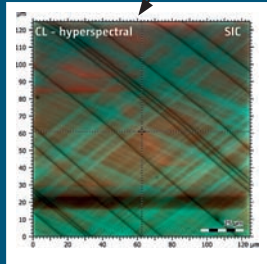

CL - Hyperspectral

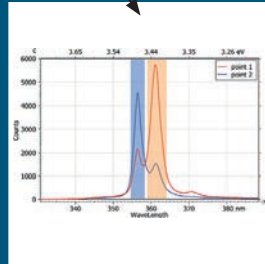

Spectra

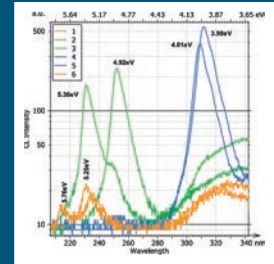

Al% in AlGaIn

Säntis 300

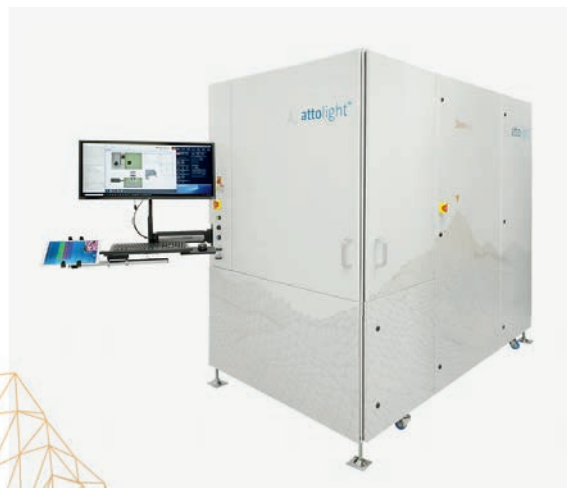

- Up to 300 mm wafer tool
- High-throughput CL-SEM
- Unique scanning modes
- Up to 300 μm FOV
- Simultaneous SEM imaging, hyperspectral imaging and Optical signature acquisition
- Automated wafer bow mapping and correction



IRPS increases its coverage of **SiC and GaN**

Reliability conference covers degradation in commercial 1200 V MOSFETs, a method for surge rating GaN FETs, and an approach to predicting the lifetime of GaN HEMTs

BY ROBERT KAPLAR FROM SANDIA NATIONAL LABORATORIES, MATTEO MENEGHINI FROM THE UNIVERSITY OF PADOVA AND AIVARS LELIS FROM THE US ARMY RESEARCH LABORATORY

OVER THE PAST FEW YEARS, interest has rocketed in the use of wide bandgap devices for energy-efficiency applications such as the electric grid, vehicle electrification, and more-electric aircraft. Deployed in these situations, devices must have a high reliability. In fact, this attribute is so crucial that it is a primary gating factor, determining the rate at which these wide bandgap devices are being inserted into these system applications.

Helping to keep track of progress to date, and identify the key challenges for tomorrow, is the International

Reliability Physics Symposium (IRPS). Held this year at the Hyatt Regency in Monterey, CA, between March 31 and April 4, the latest conference in this series featured a full programme on the reliability of SiC and GaN, the two most established wide-bandgap semiconductors. This year's attendees were able to learn a great deal about the reliability of devices made from both of these materials, as coverage of these devices provided one of the three focus topics. Insights were provided in tutorials, four technical sessions – including a focus session packed with invited talks, delivered by some of the most prominent



researchers in the field – a poster session, and several workshop sessions. In addition, IRPS hosted a meeting of the newly-established JEDEC JC-70 group, which is continuing to work on establishing reliability standards for SiC and GaN.

Helping delegates that are not that familiar with wide bandgap materials to increase their knowledge of them were the tutorials given on SiC and GaN at the start of the conference. Tsunenobu Kimoto from Kyoto University, Japan, discussed the former in a comprehensive presentation covering several key areas of SiC reliability. After providing an overview of SiC power devices and their applications, he discussed SiC material defects, degradation mechanisms that are specific to bipolar devices, and the reliability of the SiC metal-oxide-semiconductor system, which tends to employ thermally-grown SiO₂ as the oxide.

To help delegates wanting to get up to speed on GaN, Enrico Zanoni from the University of Padova, Italy, provided a tutorial focusing on failure modes and mechanisms in GaN. He spoke about microwave and power-switching HEMTs, covering topics that included: the nature and characterization of deep-level defects, both within nitride materials and at their surfaces; hot-electron effects; and breakdown in HEMT gate stacks.

Greater focus on SiC

Recently, there has been an increase in the number of papers at IRPS covering the reliability of wide bandgap devices. There are more presentations on GaN than SiC, but due to a rise of the latter, this year broke new ground with the first full technical session on SiC reliability at IRPS, held on Tuesday. It

featured an invited talk by Nando Kaminski providing an overview of the status of SiC reliability. The US Army Research Laboratory provided an updated assessment of bias-temperature instability of 1200 V SiC MOSFET threshold-voltage shifts, showing a wide variation in sensitivity to bias-temperature stress between vendors, and the importance of making fast, immediate measurements following such stress. Recent results from industry were presented as well, with GeneSiC reporting on the robustness of their 4600 V MOSFETs, and Kevin Matocha from Littelfuse giving an invited talk during the wide bandgap focus session on how to design for reliability in SiC MOSFETs. It is hoped that this is the start of a new era at IRPS, with continued robust participation by the SiC reliability community.

Also during the WBG focus session on Wednesday morning, Anant Agarwal from Ohio State University discussed different design strategies for making rugged SiC power devices. His team has assessed the performance of commercial 1200V MOSFETs produced by various vendors. This investigation revealed that the transistors exhibit a significant variance in short-circuit time, threshold-voltage shift, and gate leakage. To uncover the reasons for this, Agarwal and his co-workers subjected the devices to a series of experiments. These efforts revealed that all of the commercial SiC devices were degraded when subjected to a 10 μs short-circuit time at just two-thirds of the rated drain-source voltage. They attribute this weakness to the small device size, which cuts costs, but is impaired by a reduction in channel length.

Agarwal proposed a pathway to increase the short-circuit time: a reduction in gate voltage, possibly through the use of a source resistance. However, this may have an unwanted side-effect, as it could impact the on-resistance of the transistor.

The team from Ohio also observed a large variance in threshold voltage. They point the main finger at interface and border traps – as does the US Army Research Laboratory, which refers to border traps as near-interfacial oxide traps. This might be addressed with a suitable oxidation process that could reduce the densities of these border traps, along with a reduction in interface traps.

Assessing GaN FETs

The wide bandgap focus session also included several talks on GaN device reliability, including an invited talk, a late-news paper, and a presentation by Alaleh Tajalli from the University of Padova. Tajalli, working with ON Semiconductor, netted the accolade of the best paper presentation at ESREF – the European counterpart to IRPS – for her paper *Impact of Sidewall Etching on the Dynamic Performance of GaN-on-Si E-Mode Transistors*.

The invited GaN paper in this session came from Peter Moens, who works for the multi-national power

Left Inset:
The 2019 IEEE International Reliability Physics Symposium was held at Hyatt Regency Monterey Hotel and Spa between 31 March and 4 April. The programme chair for this meeting was Robert Kaplar from Sandia National Laboratories

electronics giant ON Semiconductor. His invited talk described a novel physical-statistical approach to AlGaIn/GaN HEMT reliability, involving the application of a forward gate stress. He and his co-workers fitted the gate-leakage curves of transistors to a physical conduction model. Plots were made as a function of temperature and field.

Using this approach, the team at ON Semiconductor has shown that the Poole-Frenkel model provides a good fit to the data. In addition, they have demonstrated that time-to-failure data shows an exponential dependence on the reciprocal of the gate leakage current.

Another key finding presented in this paper is the demonstration that all time-to-failure data can be used to extrapolate lifetime in a self-consistent manner. To do this, Moens and co-workers re-scale the time-to-failure datasets for different stress conditions to one single voltage and temperature – they select a gate voltage of 7.25 V and a temperature of 150°C. Area scaling is confirmed by comparing data from large and small transistors.

Delegates to IRPS were also able to attend two full sessions focused entirely on the reliability of GaN devices. The first, on Wednesday morning, featured a presentation by Sandeep Bahl from Texas Instruments detailing a method to validate GaN FET reliability under power line surges. Progress on this front is much needed, because GaN FETs do not tend to show avalanche capability. This has resulted in many questions from users of the devices about whether GaN FETs will be robust against power line surges. However, because of their superior transient overvoltage capability compared with silicon, GaN FETs may still be used in the design of surge-robust power supplies.

Bahl argued that the methodology used to evaluate silicon FETs is unsuitable for GaN, due to the low

avalanche energy capability of today's GaN FETs. However, GaN FETs have a higher overvoltage capability than their silicon counterparts, so these devices can operate through surges without avalanching. Based on these considerations, Bahl and co-workers have defined a methodology for the surge rating of GaN transistors, including a test-circuit, validation conditions, the specification of a device-level surge parameter, and a simulation approach, ultimately leading to a device-level surge parametric specification.

The researchers have found that GaN FETs are robust to power line surges for a bus-voltage of 720 V. This is the first time GaN FETs have been shown to be robust to power line surges and this demonstration is a step forward for the GaN industry.

On Thursday, delegates at IRPS could attend the fourth session on wide bandgap reliability (and the second focused entirely on GaN). This session featured several talks from researchers at the University of Padova.

Delivering the first of these, Abygael Viev presented results on the influence of gate length on positive-bias-temperature-instability in enhancement-mode MOS-HEMTs. During his talk, he explained why a short-channel effect might be responsible for degradation in these devices.

Following Viev came Maria Ruzzarin, who described efforts to assess the robustness of the gate oxide in a vertical GaN trench MOSFET. The design of this device structure is closer to that of a high-voltage SiC MOSFET than a GaN HEMT. Consequently, studies of this device have opened up a new research field where very few reliability results exist.

Next up, Elena Fabris detailed hot-electron effects in GaN gate-injection transistors (GITs) and variants known as HD-GITs – the latter has an additional *p*-region physically located near the drain and electrically tied to it. She explained that in these devices, hole injection from the drain *p*-region is believed to substantially reduce the parametric shifts due to hot-electron effects.

Eleonora Canato delivered the final presentation in the session. She has been examining microsecond-scale shifts in the threshold voltage of *p*-gate HEMTs. This led to the discovery of two distinct trapping processes, dependent upon the magnitude of the gate-voltage stress.

The programme at this year's IRPS highlighted the tremendous effort being devoted to the reliability of wide bandgap devices all over the world. This is set to continue, with more insights sure to be discovered in the next few years. Some of these findings will be reported at the next IRPS meeting, to be held in Dallas, TX, between March 29 and April 2, 2020.

Best paper awards

Demonstrating the great interest of the IRPS community in wide bandgap devices, this topic featured in the latest best paper and the best student paper. Announced at the 2019 meeting, the winning papers from the 2018 meeting were:

- *A Novel Insight of pBTI Degradation in GaN-on-Si E-mode MOSc-HEMT* by William Vandendaele (CEA-Leti). This award-winning paper presented, for the first time, a comparison between AC and DC stress combined with ultra-fast positive bias temperature instability measurements (<10 μs) on GaN-on-silicon E-mode MOSc-HEMTs.

- *Degradation of Vertical GaN FETs Under Gate and Drain Stress* by Maria Ruzzarin *et al.* This student paper came from a collaboration between the University of Padova and MIT.

CONNECT COLLABORATE INNOVATE



Connect with the leaders in Semiconductors, MEMS, Sensors, Flexible Electronics, Packaging, Advanced Materials, 3D, and Design and Manufacturing. SEMI gathers the global electronics manufacturing supply chain in large, medium and intimate events. Join our expositions or conferences and take your business to the next level.

**SEMICON[®]
CHINA**
FPDCHINA

**SEMICON[®]
EUROPA**

**SEMICON[®]
JAPAN**

**SEMICON[®]
KOREA**

**SEMICON[®]
SOUTHEAST
ASIA**

**SEMICON[®]
TAIWAN**

**SEMICON[®]
WEST**

M MEMS & SENSORS
Technical Congress[®]

M MEMS & SENSORS
Executive Congress[®]

M European
MEMS & SENSORS
Summit

ISS INDUSTRY
STRATEGY
SYMPOSIUM
AMERICAS

ISS INDUSTRY
STRATEGY
SYMPOSIUM
EUROPE

ASMC ADVANCED
SEMICONDUCTOR
MANUFACTURING
CONFERENCE

SMC SEMICONDUCTOR
MATERIALS
CONFERENCE
AMERICAS

SMC SEMICONDUCTOR
MATERIALS
CONFERENCE
KOREA

ITPC INTERNATIONAL
TRADE
PARTNERS
CONFERENCE

2019
FLEX
U.S.

2019
FLEX
Japan

2019
FLEX
Taiwan

2019
FLEX
Korea

2019
FLEX
China

2018
FLEX be flexible
Europe



Visit www.semi.org/events

AMERICAS • CHINA • EUROPE • JAPAN • KOREA • SOUTHEAST ASIA • TAIWAN



Delivering powerful
BLUE LASERS
to the factory floor

Powerful blue lasers are ideal for welding copper, because they hit the sweet spot for light absorption

**BY JEAN-MICHEL PELAPRAT, MATTHEW FINUF, ROBERT FRITZI AND
MARK ZEDIKER FROM NUBURU**

The largest market segment for the laser is materials processing. Used in this manner, it can serve in various industries, thanks to its capability to provide unmatched flexibility, power, and ease of integration on the factory floor (see box *Lasers for materials processing*). However, there has been one significant industrial application where the laser has not been able to succeed: copper material fabrication.

Addressing this omission is our team from Nuburu of Centennial, CO. We have produced a game-changing, high-power, industrial blue laser with unprecedented performance in copper processing applications. Our range of products began with the launch, in 2017 of the AO-150, a 150 W, 450 nm laser source, and late last year we followed this by up by introducing the 500 W AO-500.

Our innovative design has netted several prestigious industry awards. But more importantly, our powerful blue lasers have already demonstrated their worth in various applications, including battery fabrication, consumer electronics assembly, and automotive component and electric motor manufacturing.

Ready for innovation

Lasers have been proving themselves as robust, reliable tools for materials processing for many years. However, these sources have not been effective on reflective – so called ‘yellow’ – metals (see box *The physics of blue light welding*).

That impediment should not come as a big surprise – the poor performance is based directly on fundamental physics, rather than any deficiencies in the technology. What’s needed is to maintain the performance of the laser, while shifting its emission from longer wavelengths to the blue. And to do that, two developments are required: laser gain media that are efficient in the blue; and innovative design, which effectively combines independent sources to reach the required high power levels.

It is the advances in consumer electronics and general illumination that have pushed the development of blue diode lasers, which are based on GaN and its related alloys. A single diode laser typically provides only two or three watts, so to boost output, multi-die packages are put together that combine many individual diodes. The challenge is to unite the individual emitters in a manner that maintains a high beam quality while retaining optical power.

Our approach is to draw together the output of twenty diodes, packaging them in a two-dimensional five-by-

four array. This is far from trivial. Each diode has an asymmetric output, with a high-divergence ‘fast axis’ and a lower-divergence ‘slow axis.’ So, we begin by producing symmetric beams. This task cannot be accomplished with a single monolithic optical element. Instead, we use micro-optics, a solution that employs individual actively aligned fast-axis and slow-axis collimating lenses. The result is 20 highly parallel beamlets from each 20-diode package.

Each of these packages delivers an output of 50 W. So, to realise an industrially useful output power, we combine four of the 20-diode packages. To avoid unavoidable losses from traditional beam-splitters, these beamlet arrays are brought together with a series of interleaving mirrors. This creates a 5 by 16 array of spatially separated beamlets (see Figure 1(a)).

A cylindrical telescope ensures a circular beam profile for the output beams, which can be focussed to a single spot to produce an independent laser system with a nominal output of 200 W. That’s essentially a

Lasers for materials processing

MATERIALS processing requires the transfer of energy from a source to an object. This can be accomplished by transferring: thermal energy from a flame, so that it joins two materials; chemical energy from an etchant to create a surface pattern; and mechanical energy from a bandsaw to cut a material. Yet another option is to use a laser for energy transfer.

With a laser, electromagnetic energy is transferred into a material. That leads to a significant advantage over all the other energy delivery methods: in this case, energy is delivered at a distance, using a non-contact transfer mechanism. With the alternative approaches, which all require some kind of contact, one consequence is a limit to the possible geometries. In contrast, laser energy can be precisely delivered to almost arbitrarily small regions in configurations that are inaccessible to alternate methods of materials processing.

When working with a laser, energy is delivered through some combination of mirrors, lenses, and fibre optics, depending upon the specific application. All of these options can be packaged in compact, lightweight assemblies. This means that the lasers can be easily integrated into automated materials processing operations.

It follows that traditional industrial infrared lasers serve a wide variety of applications, encompassing textile cutting to automotive fabrication. That’s also why industries from consumer electronics to battery manufacturing are already integrating Nuburu’s blue lasers into their production lines.

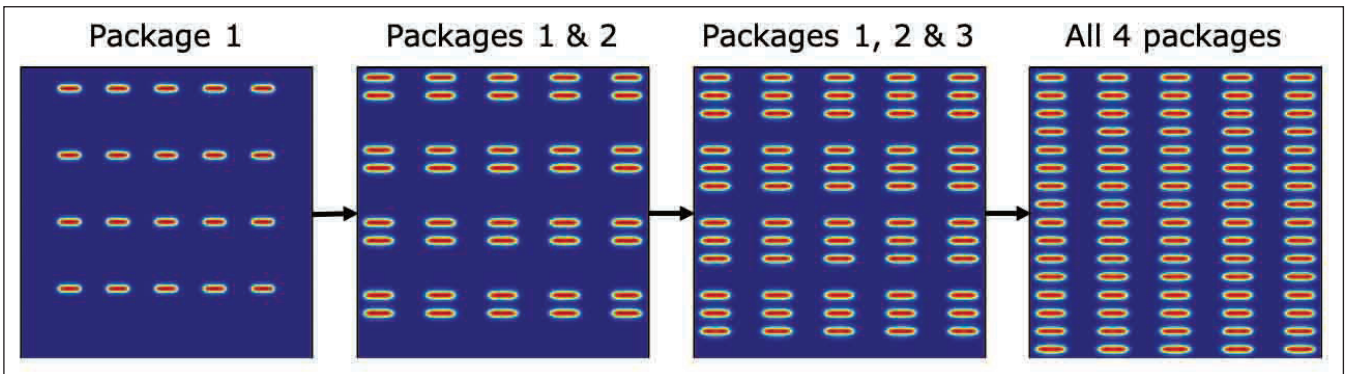
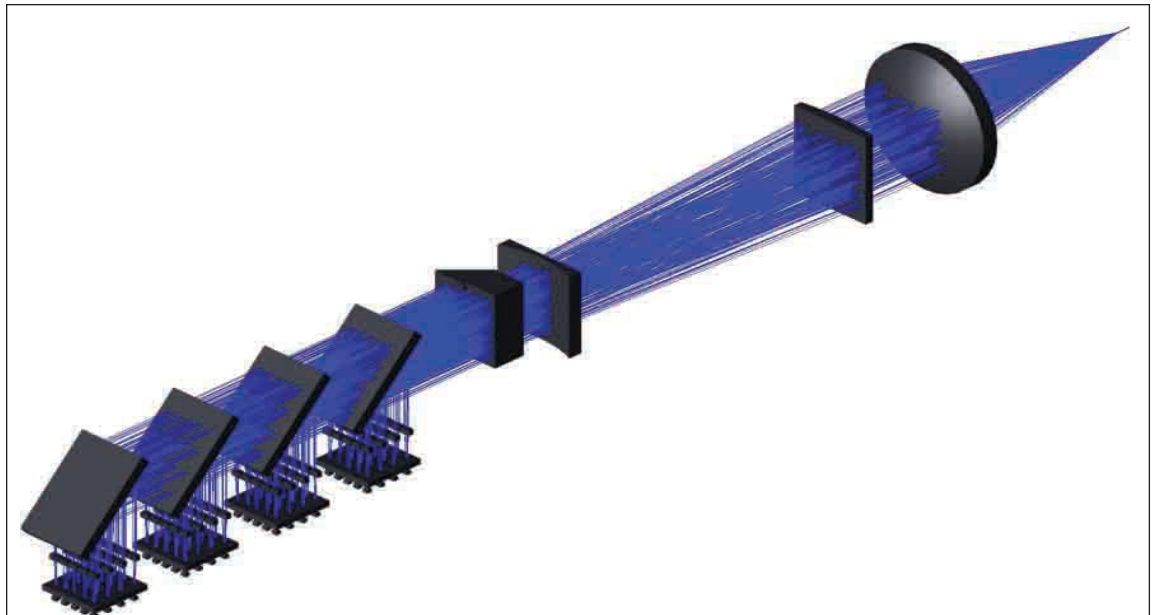

Figure 1. The optical design of a 200 W module. (a) Beamlets from four individual multi-chip packages are combined to create a single 5-by-16 output array. (b) A ray optics model of a complete 200 W module.



description of our AO-150 – our first product release (our design is shown in Figure 1(b)).

Our AO-150 has demonstrated the qualitative and quantitative advantages of using blue light for copper welding. In addition, it has confirmed the need for a higher output version.

Building on the success of our AO-150, we developed the AO-500. This 500 W, 450 nm source, which is a modular design that combines four 200 W modules, is able to expand the range of needs that can be addressed with a blue laser.

Once again, if the outputs were combined with traditional beam-splitters, too much energy would be lost. So, instead, four output modules are combined with a series of mirrors and a polarizing cube. Then finally, we aspheric lens focuses 320 beamlets into an optical fibre with a 400 μm diameter.

Using this fibre ensures that the AO-500 is not only a powerful blue light source – it's also a bright blue light source. That's a very valuable attribute, because high brightness is the key criteria for many materials processing applications (see box *The importance of brightness*).

We have paid a great deal of attention to the optical design of our products. This reaps reward, enabling a coupling efficiency of more than 90 percent into the optical fibre. But optimal performance in the lab doesn't guarantee the reliability and robustness required for sufficient performance on the factory floor.

From lab to factory

Thermal management is critical for all high-power systems. That includes optical systems, where it is crucial, because the heat load is concentrated at locations distributed throughout the system. The diode arrays are sources of heat, actively cooled with a distilled water/anti-corrosive mixture. Meanwhile, the optical fibre is a robust, quartz block-head design, capable of carrying kilowatts of optical power. By coupling more than 90 percent of the output into the fibre, the thermal load on the cladding-mode stripper is minimised. The implication is that the thermal equilibrium of the system is easily maintained, far from damage thresholds, leading to high stability and low-power degradation.

One of the strengths of the four merged 200 W modules is the significant power margin. Measurements of output power stability demonstrate a reduction of less than 3 percent per thousand hours of operational

cycling. This power margin, combined with the stability, holds the key to high reliability. Even so, every system eventually reaches the end of its useful life, which is why we build field maintenance right into our design.

Each 200 W module of our AO-500 is field replaceable, using kinematic mounting points to eliminate the requirement for optical realignment. In addition, the optical fibre can be replaced. According to laboratory testing of our module and fibre replacement, power variation is less than one percent.

Defining protocols

With innovative design established and design reliability and robustness assured, our next step is to translate the physical advantage of blue laser absorption into specific process parameters for various copper welding tasks. Material interaction may be influenced by weld speed, illumination pattern, energy density, and whether the source is operated in continuous mode or in a pulsed fashion. Working with various industrial partners, we have optimised the process parameters for different copper welds. Some of these are difficult to accomplish with other welding techniques, while others are impossible.

The capabilities of our laser include conduction welds, keyhole welds, butt welds and hairpin welds (see Figure 4). These joints, which are essentially void- and spatter-free, are produced at rates well above those of alternative methods.

These unprecedented quantitative and qualitative advantages associated with our blue lasers have already led several key battery, consumer electronics, and electric motor manufacturers to incorporate welding with these sources into their processes.

We continue to perform tests to determine the welding parameters appropriate for specific assembly geometries. Efforts are directed at developing higher power, higher brightness sources, opening up new prospects for applications in a wider range of industries.

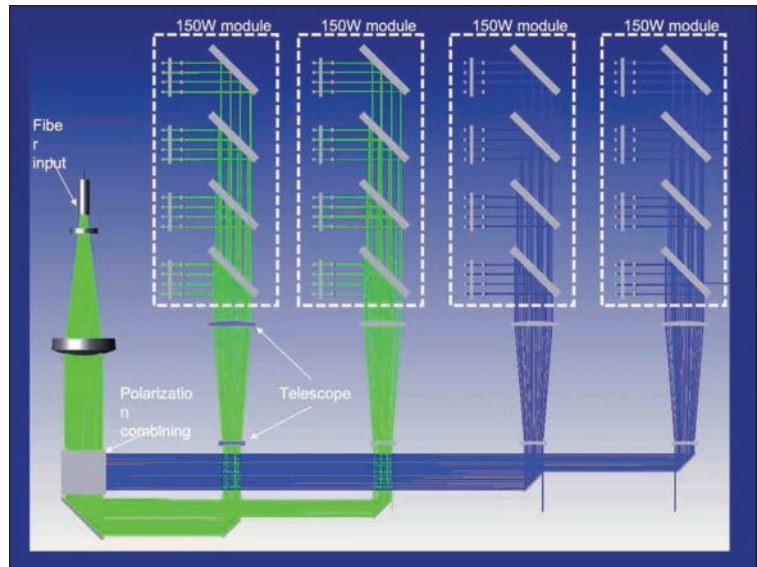

Figure 2. Four separate 200 W modules are combined with mirrors and a polarising cube. 320 beamlets are focussed through an aspheric lens into a 400 μm-diameter optical fibre.

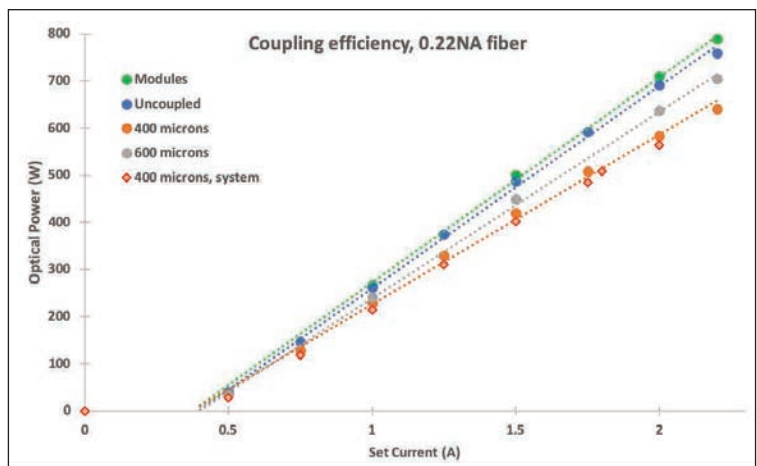

Figure 3. The AO-500 system reliability. (a) The output power of the modules, demonstrating the high efficiency of power coupling at each level of integration.

The importance of brightness

The interaction of a laser beam with a material doesn't depend on the beam's energy, but its energy density, which is increased by focusing. A common metric when considering the energy density is the beam parameter product: it is calculated by multiplying the laser beam's smallest radius and its divergence angle. Note that the initial beam parameter product limits the performance of any subsequent beam conditioning. Or, to put it another way, the beam parameter product can't be improved by adding optical elements.

A light source's brightness is defined as its power per angle per area. That's essentially the power divided by the beam parameter product. Note that the beam parameter

product determines the smallest focus spot for a beam, and the brightness determines how much energy will be concentrated in that spot. The important point is that a higher brightness source can deliver higher energy density to a target material.

What this means is that the higher the power density, the faster and deeper the weld. Increase the power density by about a factor of four, and the speed of the weld can increase by a factor of three to four for the same weld depth; or the speed can be maintained, while penetrating 60 percent deeper.

The physics of blue-light welding

LASER WELDING begins when light is absorbed by a material and converted into heat. The energy density delivered at the metal surface governs which of the three types of weld are created: a conduction weld, a keyhole weld, or 'transition-mode' weld. A conduction-mode weld occurs when the laser delivers energy to the surface, forming a wide, essentially symmetric shallow weld nugget, through conduction of heat from surface absorption. Keyhole-mode welding results from absorption at a higher energy density. The laser light creates a thin pencil through the material – a 'keyhole' – opening a path for laser energy to be delivered directly to the full thickness of the material. A melt pool is produced in the wake of the laser's path. The third type of weld, the transition mode, is, as its name suggests, an intermediate state between conduction and keyhole welding.

The Achilles heel of the traditional industrial laser is its wavelength. Depending on its type, it either emits in the neighbourhood of 10 μm or at around 1 μm . That's far from ideal for processing 'yellow metals', such as copper, because they have very weak absorption in this spectral range.

That poor absorption prevents conventional industrial lasers from delivering conduction-mode welding. Keyhole welding is possible, but only by delivering significant excess energy to the target area. Once the melt pool is formed, however, material absorption is far higher.

The excess energy that is needed to initiate and maintain the weld creates high and low pressure bubbles within the melt pool. Both are undesirable: high-pressure bubbles eject

material from the weld, creating 'spatter'; while low-pressure bubbles can't break free from the melt pool, so are frozen in place, creating voids in the weld. The spatters are voids that compromise the mechanical and electrical integrity of the joint, as well as creating contamination around it.

One way to try and minimise these problems is to modify the illumination pattern. This can be accomplished by 'wobbling', which involves irradiating the surface in a spiral-like pattern to moderate the energy delivery. But this approach is far from ideal, as it reduces the weld speed and fails to eliminate voids and spatter.

In practice, those that are welding copper with infrared lasers are forced to walk a narrow path, making sure that they supply enough energy to ensure a weld, but not too much, to prevent the weld from degrading. That means that there is a very narrow process window to produce any kind of weld – and sometimes there is no process window at all.

Switching the light source from infrared to blue changes everything, thanks to a ten-fold hike in absorption. With a blue laser, conduction mode welding is possible. Welding is also far easier, because both the base copper and the melt pool absorb about two-thirds of the incident blue light. Although this absorption changes with temperature, it does so in a smooth manner. This means that the process remains under very tight control at every stage, with a wide process window. The upshot is high-speed welding that's free from voids and defects – a performance that can't be matched with any other welding technology.

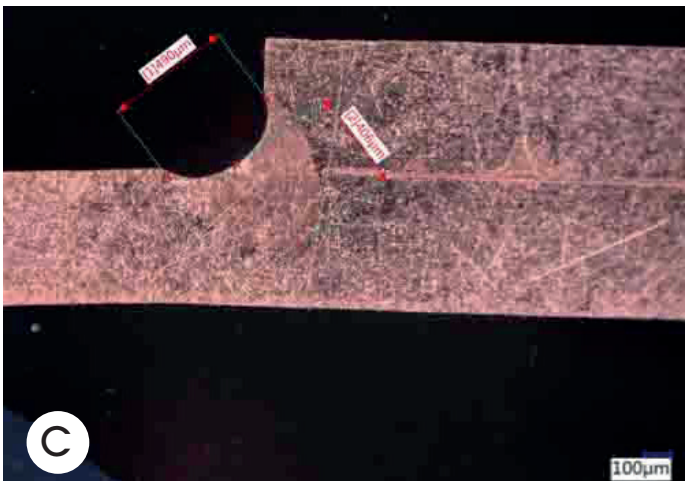

Figure 4. Blue laser copper welds, all void- and spatter-free. (a) A conduction mode weld. (b) A keyhole mode weld. (c) A butt weld for a bussbar. (d) A hairpin weld, as required for an ultra-compact electric motor assembly. Note that (c) and (d) are essentially impossible with alternative weld methods.

CS INTERNATIONAL CONFERENCE

31 March - 1 April 2020

Why should you choose to sponsor with CS International in 2020?

- Are you looking to accelerate your growth and reach the major players in the compound semiconductor industry?
- Do you want to educate, influence and network with the industry?



If you have answered yes to any of the questions above, then CS International 2020 is the perfect event for you. Here are but a few reasons why you must consider sponsorship.

Reasons to sponsor

1. Access and network with the top strategists within the compound semiconductor industry

As the market leading global compound semiconductor conference for almost a decade, CS International 2020 will allow you to engage with 350+ senior decision makers from the major companies along the entire value chain of the compound semiconductor industry in one dedicated exhibition hall, including over 30 international experts, who will speak at the conference.

2. Raise brand and company awareness

We have an intensive and multi-faceted marketing program available and already underway, which includes email marketing, social media, conference partners, direct mail and live events in addition to promotion in the prestigious Compound Semiconductor print and digital magazine. Coupled with the marketing program, the support of our highly esteemed Conference association and media partners ensure your company, product and service will achieve maximum visibility within the compound semiconductor industry for the next 6 months.

3. Thought leadership and credibility

Aligning with the premier compound semiconductor conference will give you a great opportunity to be positioned as a thought leader in the industry. Engage in debate, share insights and expertise on industry challenges with your peers.

4. ROI and long-term partnerships

Many of our sponsors repeatedly support the event year on year, demonstrating how the industry trusts the CS International brand as the leading information and networking resource to deliver the best programme and ROI. Unparalleled networking opportunities enable you to both build existing and generate new relationships and demonstrate ROI by aligning with the conference brand.

5. Accessibility

We have opportunities to suit all budgets.

6. Post-event exposure

Even when the event is over, you will be included in off-season conference promotional activities, plus the CS print and digital magazine as well as the weekly email newsletter.

Contact: sponsor@cs-international.net to discuss opportunities with the CS International Conference and Exhibition team or by calling +44 (0)2476 718 970 today.

Sponsorship opportunities are limited.

Building better lasers on low-cost silicon

The silicon photonics revolution is gathering pace, thanks to the introduction of powerful lasers that don't require an insulating intermediary layer

BY DONGJAE SHIN AND KYOUNGHO HA FROM SAMSUNG ADVANCED INSTITUTE OF TECHNOLOGY, SAMSUNG ELECTRONICS

BACK IN THE MIDDLE of the twentieth century, a revolution took place in the electronics industry. Out went the vacuum tube and in its place came the integrated circuit.

Now this industry is starting to embark upon another major change. There is a shift to the optical domain, driven by scalability limitations associated with some electric ICs, along with the promise of newly emerging applications. To usher in this new era, money is pouring into silicon photonics technology, enabling the integration of photonic devices.

Part of the motivation behind this investment is that there are several applications where the addition of photonic ICs could aid 'mother' electric ICs. They include CPU-memory interconnects, an opportunity that has been discussed for several decades.

Introducing inter-chip optical interconnects could obliterate bandwidth and capacity limitations coming from today's copper interconnects, which are hampered by impedance mismatches between the CPU and the dual-inline memory modules. This could create a form of DRAM with an optical interface, formed by integrating silicon-photonics-based optical transceivers in the DRAM on the bulk-silicon platform (see Figure 1).

This vision does not quite align with the majority of effort within the silicon photonics industry, which has focused on a special integration platform called silicon-on-insulator (SOI). This platform simplifies and

speeds development, but has a fundamental flaw: it is incompatible with conventional general-purpose substrates, known as bulk-silicon, that are used for most legacy electrical ICs. While there is no question that SOI is convenient for implementing photonic ICs at an early stage, it is likely to be a stumbling block to the evolution of electric-photonic ICs.

For this reason, at Samsung Advanced Institute of Technology, we are pursuing photonic IC technology on bulk silicon. Our breakthrough is the development of integrated lasers, implemented with a direct bonding process on the bulk-silicon platform. Our success provides a small but significant step towards the integration of photonic functions into legacy high-volume products, and it could contribute to mainstream semiconductor product evolution.

It makes sense for some smaller companies to develop their photonic technology on SOI, because the size of the emerging market for their technology is large enough for them. But for those of us that are players in the major semiconductor industry, which is already mass-producing electric IC products, the focus tends to be on the electric-photonic ICs. It is this technology that could support the electrical IC market of the future (see Figure 2).

The pace of development of silicon photonics that are based on the bulk-silicon platform has been slower than that on SOI. However, there has been progress on bulk-silicon, and the main device library is now almost complete.

On the bulk silicon platform, developing the integrated laser is the biggest challenge. This building block, like all photonic devices on bulk silicon, suffers from a relatively high optical loss compared with the SOI platform. However, bulk silicon also has its upsides, including a lower cost and a superior heat dissipation that improves laser performance. It is these merits that give the implementation of electric-photonic ICs so much promise.

SOI versus bulk silicon

Despite a cost that is an order of magnitude higher than that of bulk silicon, SOI substrates are firmly established as the mainstream platform for silicon photonics, due to their ease of fabrication, and the low optical loss of the optical waveguides. At the heart of this technology is a global intermediary layer called a buried oxide. It sits beneath the thin crystalline silicon layer, where it creates a low-loss optical waveguide, by surrounding the high-index crystalline silicon core with a low-index oxide cladding. The downside of this architecture, as mentioned before, is its heat dissipation – the thermal conductivity is two orders of magnitude lower than that of silicon.

As this bulk-silicon platform is far lower in cost, and is currently used in most high-volume IC products, it is likely to be used in future electric-photonic ICs. With this platform, it is possible to add a buried oxide locally, under just the optical waveguide. This can impede light leakage, as well as increasing heat dissipation to the substrate, a move that prevents a plummet in the performance of temperature-sensitive devices.

One of the challenges with bulk-silicon technology is realising a layer of low-loss crystalline silicon on top of the amorphous buried oxide. Recently, however, we have made much progress on this front, using heat treatment to crystallise the amorphous silicon that has been deposited on the buried oxide. Although the optical waveguide loss for the crystallised silicon on the bulk-silicon platform is higher than that for

crystalline silicon for SOI, it is still low enough to serve in photonic ICs with relatively short optical waveguides.

Integrating III-Vs with silicon

As silicon lasers are still in their infancy, the lasers that are deployed in silicon photonics have to be made from III-Vs. The goal is to ensure low-cost coupling between the III-V laser and the silicon chip. Many solutions have been proposed, ranging from packaging-level assembly to process-level integration. With the assembly approach, the challenge is to realise high-precision optical alignment at low cost, while integration is held back by the substantial investment required to set up integrated processes for handling heterogeneous materials.

Once again, the approach that is adopted is dictated by the size of the industry. If it is small, the preference is on assembly, which provides a swift response to the emerging market; but if a company is operating in the major semiconductor industry, its interest



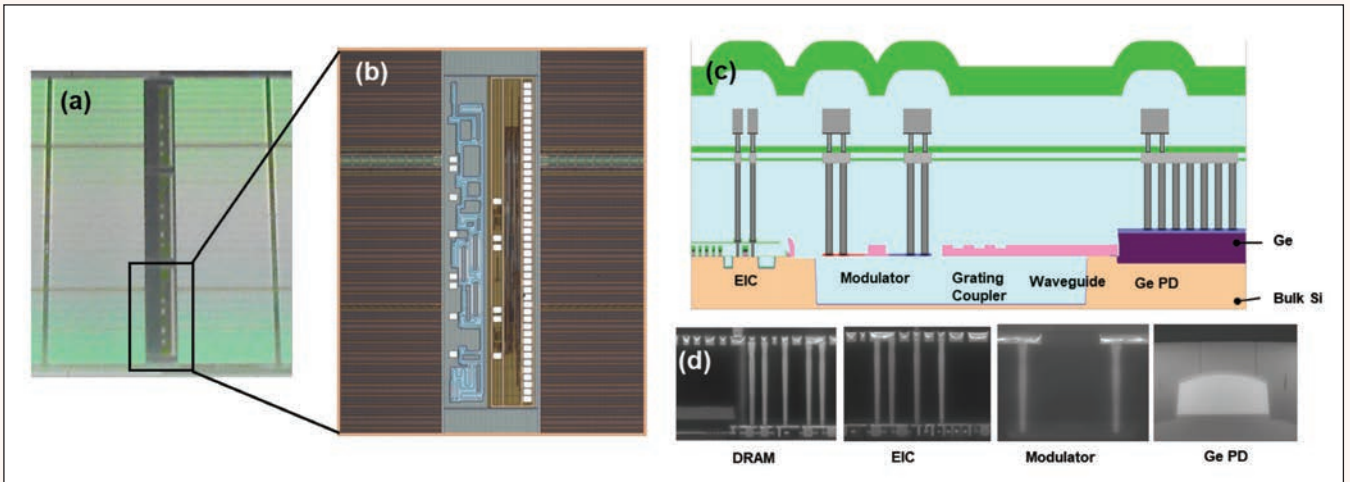

Figure 1. (a) Optical microscope image of a DRAM periphery section. (b) Optical microscope image of the electric-photonic IC. (c) Schematic of the electric-photonic IC vertical structure. (d) Scanning electron microscopy images of the DRAM, electric IC, modulator, and germanium photodiode. Note that this approach, outlined by Samsung in 2013, did not include the integration of lasers.

lies in integration, with greater focus on high-volume manufacturing. Turning to integration avoids unacceptable increases in packaging costs, which are forbidden in the major semiconductor industry.

The bonding process is a popular short-term approach to integrating III-Vs and silicon. It overcomes the difference in the lattice constants of heterogeneous materials. Epitaxial layers of III-Vs are grown on a native substrate, before this epiwafer is flip-chip bonded to a silicon substrate that features pre-patterned silicon photonics structures. After the bond has been strengthened with a heat and pressure process, integrated lasers are formed using photolithography and III-V processing. The accuracy provided by lithography eliminates additional alignment.

Unfortunately, the scale and the maturity of silicon and III-V processes are very different. Consequently, integrating them is hampered by various technical and business issues, which may only be addressed with engagement of the overall semiconductor industry. When pursuing this approach to integration, the first

hurdle is to develop a good enough bonding process. Options include buffered bonding and direct bonding (see Figure 4). The former has fewer challenges, but the latter delivers a simple silicon-to-III-V connection with diminished wavelength dependency.

From a thermal perspective, direct bonding is better, because silicon tends to have a higher thermal conductivity than the buffer layer. Given the great thermal management associated with the bulk-silicon platform, it appears to be worthwhile to maintain this asset when bonding. Refining the process, so that it is well-suited to high-volume manufacture, is a goal for those that work in research and development.

Building lasers on bulk silicon

With the bulk-silicon platform, a crystallized silicon layer must be formed on top of the local buried oxide. We do this with our proprietary solid phase epitaxy process. Essentially, this is a form of mild thermal annealing that turns amorphous silicon to crystallized silicon that mirrors the crystalline seed of the substrate. The crystallinity of the substrate propagates upwards in the regions directly contacting

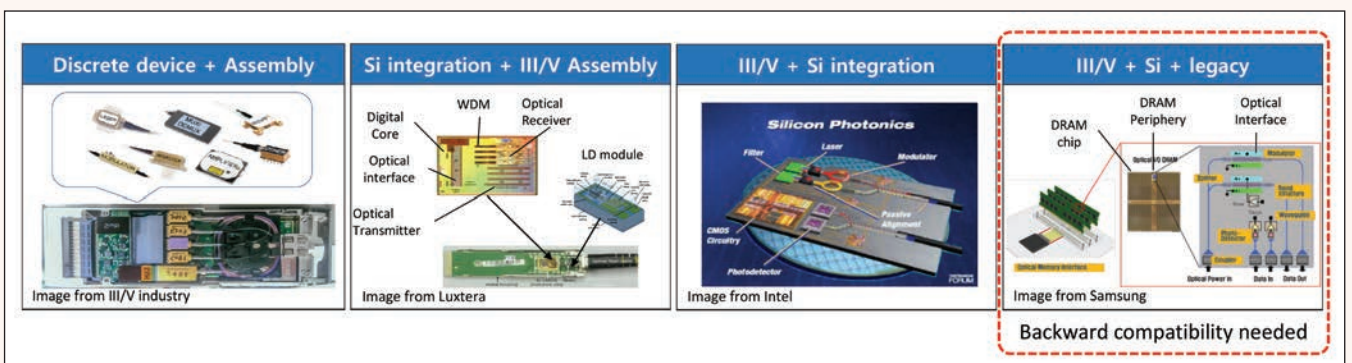

Figure 2. The photonics industry is pursuing several different approaches to unite III-V and silicon technologies. For the last stage of the integration with legacy technologies, photonics integration needs backward compatibility with the legacy platform.

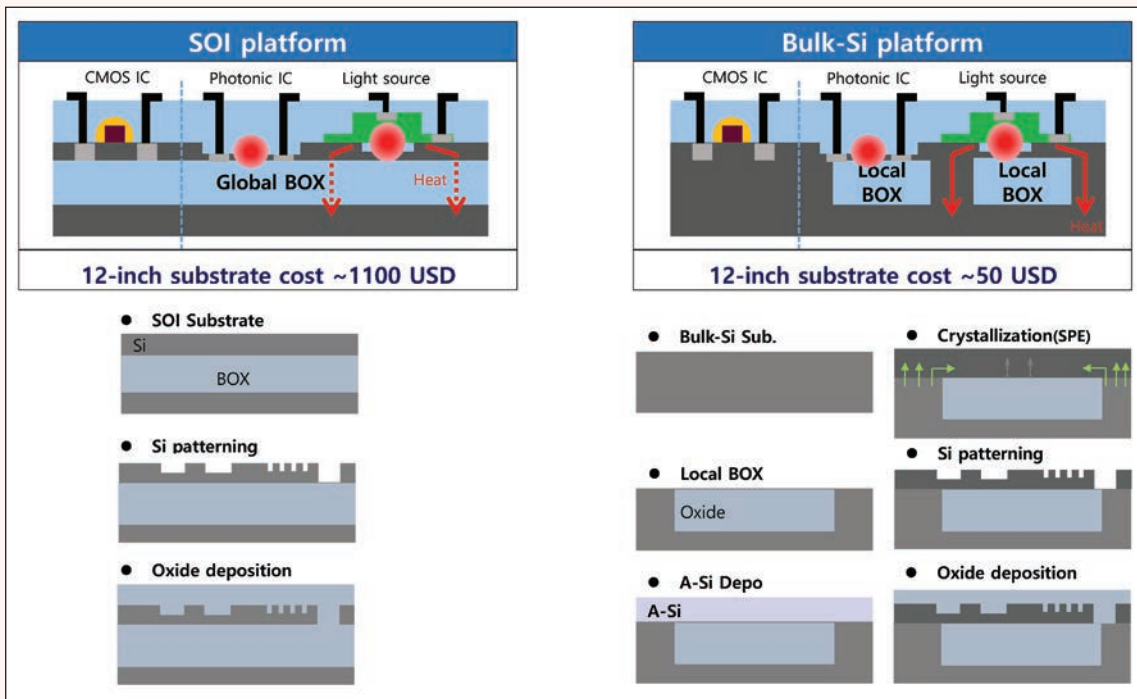

Figure 3. Despite its high-cost substrate, the SOI platform has been dominant in the photonics industry. Merits of the bulk-silicon platform include its low-cost substrate, and its attractiveness for forming electric-photonic ICs. A noteworthy difference between the two architectures is that the SOI platform features a global buried oxide (BOX), while the bulk-silicon platform employs a local BOX.

the amorphous layer, and propagates sideways over the local buried oxide.

Note that for the silicon at the centre of the local buried oxide, crystallization propagates from both sides – and when they collide, the result is poor crystallinity, known as coalescence. To prevent this poor crystal quality from impairing the performance of the optical waveguide, its location deliberately avoids the coalescence regions.

Putting aside for one moment the use of a local buried oxide and the offset location of the optical waveguide, we employ a process and structure that are similar to the SOI platform. However, our approach offers some advantages over this in terms of flexibility, as we can use arbitrary thicknesses for the silicon layers, the buried oxide, and the polysilicon reflective layers.

The most common method for getting the output of a discrete laser into a waveguide is butt-coupling. This is accomplished by aligning the laser and the waveguide on the same optical axis. In this configuration, the optical mode is positioned at the centre of the laser active region to maximise efficiency.

In this regard integrated lasers are very different, due to the evanescent coupling. The III-V active region is attached to the top of the silicon waveguide, allowing the evanescent tail of this device's emission to couple with this waveguide. Due to this unique feature, the optical mode is not at the centre of the integrated laser, but distributed over both the III-V and the silicon structures.

With this design, the silicon waveguide provides a resonating cavity structures to the optical mode, and

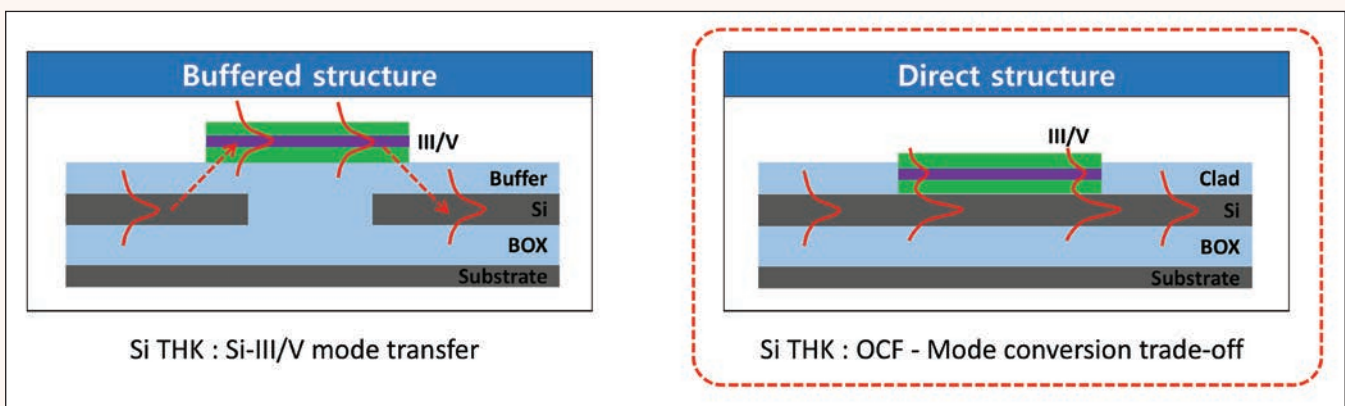

Figure 4. The two main options for bonding are buffered bonding and direct bonding. The buffered structure takes full advantage of the traditional III-V active design and focuses on the smooth laser-waveguide mode transfer. The direct structure relies on an active design that depends on the III-Vs and silicon, and is capable of realising smooth laser-waveguide mode conversion. The thickness of the silicon plays an important role in mode transfer or mode conversion.

the III-V active region provides optical gain to the optical mode. It is this interplay of the gain and cavity, and how the optical mode is distributed over the silicon and III-V regions, that governs the performance of the integrated laser. For example, if the optical mode is primarily in silicon, this trims the internal loss, cavity loss, and laser-waveguide coupling loss, but at the expense of a reduction in optical gain from the III-V active region. Since the ratio of the optical mode in the III-Vs to that in silicon is determined by the waveguide dimensions, as well as the structure and the thickness of the III-V region, laser development cannot ignore the interplay of the silicon and III-V structures.

Like III-V discrete lasers, if integrated lasers are to work well, the electrical currents must be concentrated in the optical mode. To do this, we use a proton implant process to make the III-V mesa edges non-conductive (see Figure 5). The proton-implanted regions actually serve two purposes: they act as a funnel for current concentration, and they aid the transfer of heat from the active region to the silicon layer. Current is vertically injected into the optical mode from the *p*-type electrode that sits on top of the III-V mesa, and then it flows in the horizontal direction to drain into the *n*-type electrode.

Optimising the performance of this laser is not easy, due to the interplay of various characteristics. One option to increase the laser efficiency is to shorten the current path, which cuts electrical resistance. But if a low thermal impedance is also required, accomplishing this by widening the III-V mesa and lengthening the horizontal current path, leads to

a higher electrical resistance and a lower laser efficiency.

Tuning the wavelength?

Depending on the application, the photonic IC may require a laser that emits a single-wavelength or one with a tuneable output. This difference lies in the cavity structure in the silicon side of the integrated laser.

For single-wavelength lasers, the most popular design is the distributed feedback laser (see Figure 6 (a)). By forming a cavity at a single wavelength through a specific grating structure, emission is restricted to a single mode, regardless of driving conditions.

The key metrics for the single-wavelength laser are the wall plug efficiency and the side-mode suppression ratio, which is a measure of the dominance of the lasing mode. In a typical III-V laser, the wall plug efficiency falls as the temperature of the device increases, due to reductions in the gain and the bandgap of the III-V material. In the integrated laser, the situation is more complicated. The thermal behaviour of the silicon must also be considered, and whether its pairing with the III-Vs can apply the brakes to the reduction in wall-plug efficiency with temperature. We have strived to improve the performance of our integrated lasers. This has led us to realise a single-port wall-plug efficiency of 8 percent up to 70 °C and a side-mode suppression ratio of 45 dB (see Figures 6 (c) and (d)).

Several designs are capable of producing a wavelength-tuneable laser. Our device is based

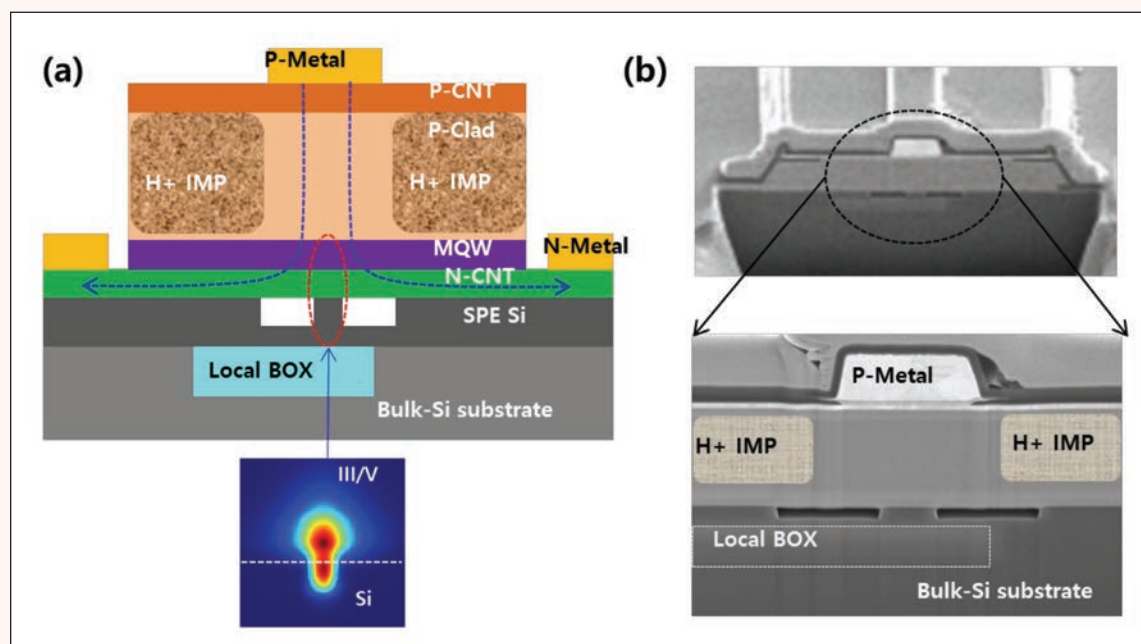

Figure 5. The integrated laser on the bulk-silicon platform includes: a III-V epitaxial layer directly bonded to the pre-patterned silicon wafer; current confinement, realised with the proton-implanted III-V mesa structure; and optical confinement, resulting from the III-V mesa on top of the silicon rib waveguide. Note that to minimise optical loss, there is the lateral offset between the local buried oxide (BOX) structure and the rib waveguide.

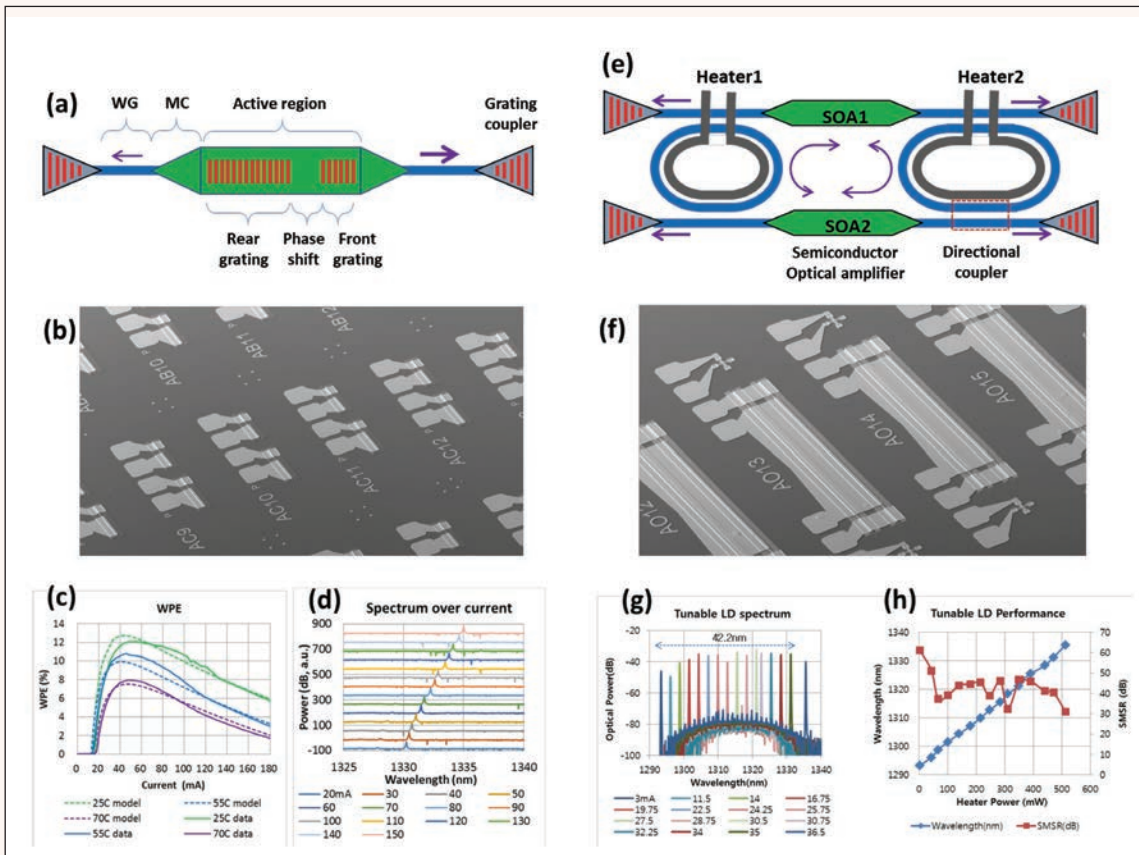

Figure 6. Engineers at Samsung Advanced Institute of Technology have used a bulk-silicon platform to produce and evaluate single-wavelength integrated lasers (see (a) to (d)), and wavelength-tuneable integrated lasers (see (e) to (h)). The single-wavelength laser is a distributed feedback design that realises a high side-mode suppression ratio, and features a quarter-wavelength phase-shift section in the distributed feedback grating (a). Note that this short phase-shift hampers a high wall-plug efficiency, but guarantees single-mode stability. In the integrated lasers, thanks to fine tuning of the design and high precision of the silicon process, it is possible to suppress the deterioration of the mode stability in a longer phase-shift design. To enhance the main-port optical output, the design incorporates an asymmetric cavity structure with different grating lengths on both sides of the phase shift. The wavelength-tuneable laser features a ring-based mirror, with the ring resonator inserted between the two straight waveguides (e). With an optical input to one waveguide, the other waveguide outputs the so-called wavelength comb according to the input wavelength. The result is a mirror-like operation at the selected resonant wavelengths. Note that the ring size determines the wavelength comb periodicity. So, with two rings of different sizes, each ring mirror reflects only at the wavelength comb of a different periodicity. This means that the laser cavity is formed only at the wavelength where the two wavelength combs overlap. If one wavelength comb is then spectrally shifted by the embedded heater of the ring, this action will shift lasing to the adjacent mode in the wavelength comb. (b) and (f) are scanning electron microscopy images of the single-wavelength and tuneable integrated lasers, respectively. (c) Wall-plug efficiency of the single-wavelength laser at 25°C, 55°C, and 75°C. The continuous lines are measurements, and the dotted lines are from a laser model. (d) Optical spectra of the single-wavelength laser, driven at operating currents from 20 mA to 150 mA. (g) Optical spectra of the wavelength-tuneable laser, for a range of heater currents. (h) Lasing wavelength and side-mode suppression ratio extracted from the optical spectra.

on a popular design that features two ring-based mirrors (see Figure 6 (e)). The range of tuning can be broadened with laser mode hopping through the Vernier effect.

With this class of laser, the range of tuning is paramount. Using a proper ring design, we have produced a tuning range of 42.2 nm on the bulk-silicon platform (see Figure 6 (g) and (h)).

Thermal advantage

We have evaluated the thermal advantage of our bulk-silicon platform by measuring the thermal impedance of our single-wavelength integrated laser. The thermal impedance is defined by the ratio of the temperature change of the laser’s active region, relative to its input electrical power. The greater the heat dissipation, the smaller the impedance. We have found that moving from an SOI integrated laser to one that is on bulk

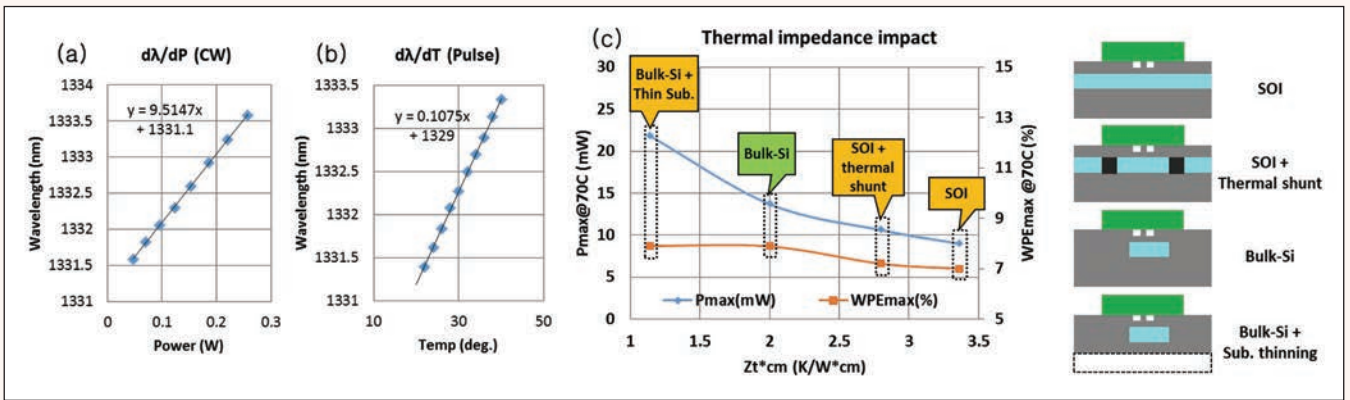

Figure 7. Thermal analyses of the single-wavelength laser on the bulk-silicon platform. It is challenging to undertake direct measurements of local temperature change in the active region, so this characteristic is indirectly measured through lasing wavelength change. Rates of lasing wavelength change are measured in terms of temperature and input power, with the ratio of these two revealing the thermal impedance. (a) Lasing wavelength shift over increasing power in continuous operation. (b) Lasing wavelength shift over increasing temperature, using pulsed excitation with a 0.1 percent duty cycle. (c) The maximum output power and the maximum wall-plug efficiency at 70 °C, calculated using the laser model for the four platforms of interest. The calculation is calibrated with the measured data of the bulk-silicon platform.

silicon cuts thermal impedance by about 40 percent, assuming no change in the length of the device.

To evaluate the impact of this improvement in thermal impedance on laser performance, we have turned to a measurement-calibrated theoretical model. Based on this insight, at 70 °C we predict that compared to the SOI platform, the use of bulk-silicon enables a 52 percent hike in the maximum optical output power and a 13 percent increase in the wall plug efficiency (see Figure 7). And if we were to thin the substrate, the resulting reduction in thermal impedance could increase the maximum optical output power at 70 °C by more than 140 percent. Based on this modelling, the bulk-silicon platform is particularly promising for electric-photonic ICs that require either many temperature-sensitive devices or high-power lasers.

Addressing reliability concerns

Due to the significant difference in the thermal expansion coefficients for silicon and the III-Vs, there are concerns related to the reliability of integrated lasers. On the SOI platform, a typical reported value for the average lifetime at 70 °C is about 40,000 hours.

That’s slightly shorter than the average lifetime of our lasers on bulk-silicon. They have a lifetime of about 46,000 hours at 70 °C (see Figure 8).

Is this long enough? Well, due to the difficulty of optical fibre deployment, conventional long-distance fibre systems typically require long-term reliability of more than 10 years – or nearly 90,000 hours. However, recently constructed data centres adopt a crop-rotation-like replacement of optical interconnect modules, deploying new product every three to four years. So, for applications such as data centres, where long-term reliability is not essential, our lasers show much promise.

Further reading

Dongjae Shin *et al.* “Heterogeneously integrated light sources for bulk-silicon platform,” IEDM2018, 23.6 2018

Dongjae Shin *et al.* “Integration of silicon photonics into DRAM process,” OFC 2013, OTu2C 2013

Figure 8. (a) A high-temperature operating lifetime test, conducted at 70°C, run over 1900 hours with 24 single-wavelength lasers. The output power was set to 6 mW. (b) The cumulative failure plot provides an estimate for device lifetime.

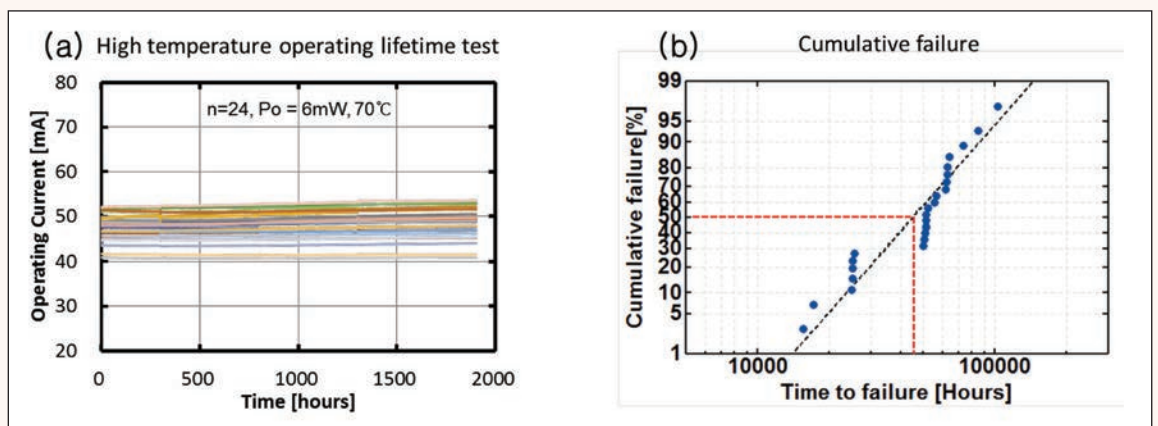

3 EVENTS

2 DAYS

1 TICKET

31 March - 1 April 2020

Sheraton Brussels Airport Hotel, Belgium

One ticket gives you access to a 2 day event which will see 3 groups of device makers gathered under one roof.

Hear over 100 presentations covering the entire spectrum of the compound semiconductor, integrated photonics photonics and global sensor supply chain.

**CS INTERNATIONAL
CONFERENCE**

Connecting, informing
and inspiring
the compound
semiconductor industry

www.cs-international.net



**Talk to us about sponsorship NOW
as it will be another sellout**

**PIC INTERNATIONAL
CONFERENCE**

Creating and
strengthening
links between
chipmakers and
network builders

www.picinternational.net

**SSI INTERNATIONAL
CONFERENCE**

Sensor Solutions:
Market opportunities



www.sensors-international.net

REGISTER NOW, AND SECURE YOUR PLACE. REGISTRATION ALLOWS ACCESS TO:
CS INTERNATIONAL, PIC INTERNATIONAL AND SSI INTERNATIONAL



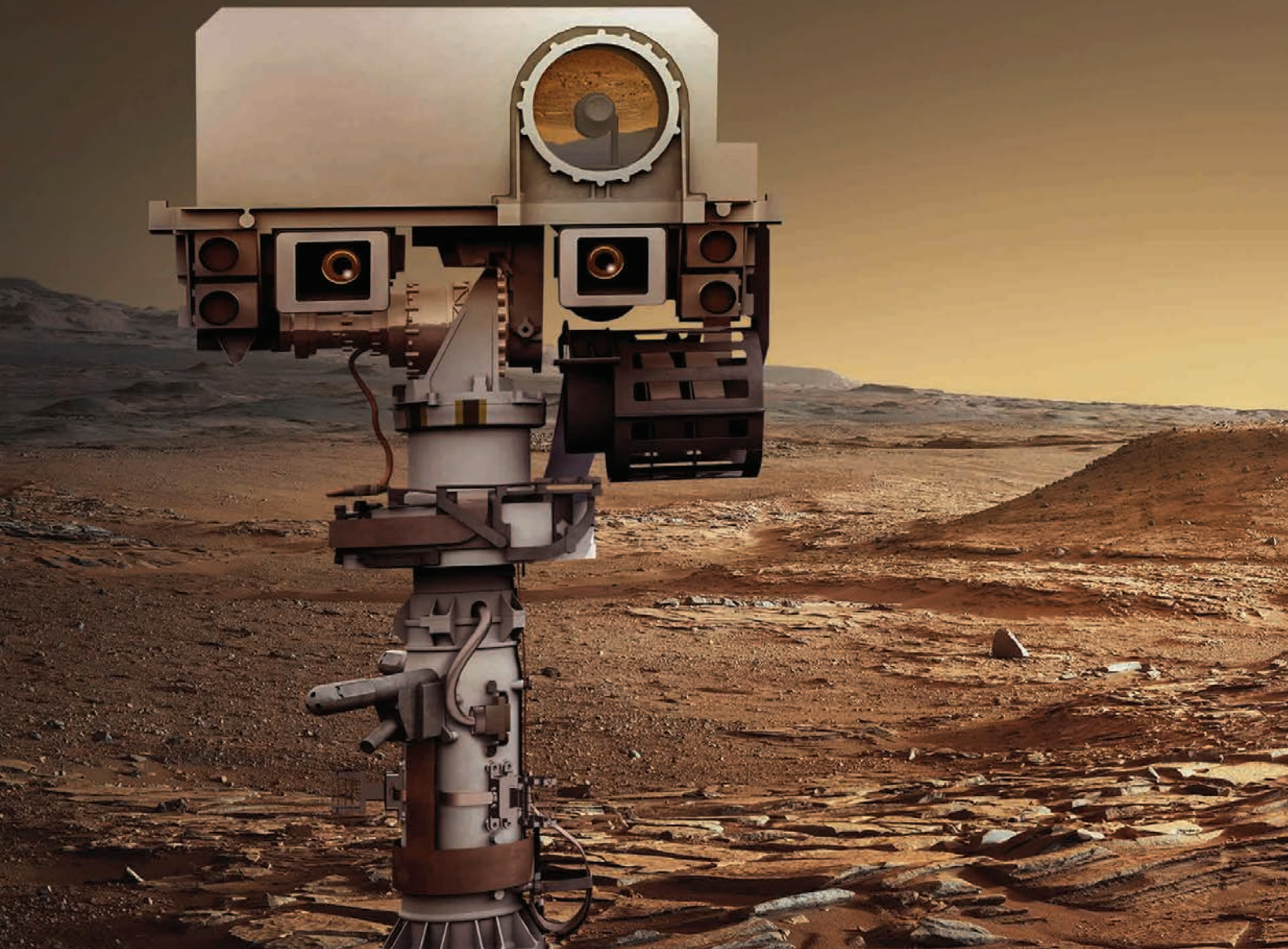

Interband cascade lasers target the mid-infrared

Inventor of the interband cascade laser, Rui Q. Yang from the University of Oklahoma, details the progress of this powerful, efficient mid-infrared light source that combines the best assets of laser diodes and QCLs



THERE IS A STRONG, ever growing demand for reliable semiconductor lasers emitting in the mid-infrared. Sources in this spectral range, which extends from 3 μm to 12 μm , are required for many applications, including environmental and chemical-warfare monitoring, gas sensing, the detection of pipe leaks and explosives, food safety, industrial process control, medical diagnostics, infrared lidar, free-space communications and infrared illumination.

Producing an efficient, compact mid-infrared semiconductor laser is far from easy, due to a combination of fundamental and technological issues. But it can be done, by pursuing less common architectures, such as interband cascade lasers (ICLs) and quantum cascade lasers (QCLs).

These cascade-based devices are needed, because the conventional diode laser struggles to operate in the mid-infrared. Its emission is determined by its

bandgap (see Figure 1 (a)), and it's impossible to reach the mid-infrared with either of the two more mature material systems, the arsenides and the phosphides. Meanwhile, narrower bandgap materials are held back by weaker bonding between their constituent atoms.

An additional drawback of the conventional diode laser is that as the emission wavelength stretches further into the infrared, there is a hike in non-radiative loss mechanisms, such as Auger recombination, while other issues come to the fore, including inadequate electrical confinement, poor efficiency in utilising the bias voltage, a non-uniform distribution of injected carriers and increased free-carrier absorption loss. Given all these impediments, it is of no surprise that mid-infrared diode lasers, such as lead-salt lasers that are based on IV-VI materials, need to be cooled with liquid nitrogen to operate, and they produce a feeble output power while suffering from mode-instability.

Interband cascade lasers have been used to hunt for methane on Mars

Despite all these difficulties, progress has been made with the conventional architecture, in the form of a type-I GaInAsSb quantum well diode laser. It can deliver room-temperature emission, but only up to wavelengths of about $3.7\ \mu\text{m}$ – try to push the output further into the mid-infrared, and threshold current densities rise rapidly (see Figure 2).

Turning to the ICL tackles many of these issues. Similar to the unipolar QCL, where the wavelength of its emission is determined by its intersubband energy difference (see Figure 1(b)), high quantum efficiencies result, with every injected electron cascading through several stages connected in series, to generate multiple photons (see Figure 1(c)). As this mode of operation ensures uniform injection of electrons over every stage, the carrier concentration required for threshold is lower than that in conventional diode lasers, resulting in reduced optical and Auger losses

and a lower threshold current density. This allows the laser to operate at a lower current, trimming the parasitic loss due to electrical resistance to a value below what it would be in a conventional diode laser.

When it comes to design, there are also advantages associated with the ICL. Conventional bipolar diode lasers require *n*-type and *p*-type cladding regions, while ICLs just need an *n*-type cladding, inserted at either end of the cascade stages to transfer electrons in and out. Eradicating *p*-type layers is beneficial, because they tend to absorb more light than their *n*-type counterparts, and thus result in higher losses. Note that the interfaces between the adjacent cascade stages can be viewed as semi-metallic, in which electrons and holes are generated internally.

A significant difference between the ICL and the QCL is the light-generation process. Lasing in a QCL results from intersubband transitions, dominated by fast phonon scattering, occurring on a time scale of picoseconds or less. Meanwhile, with ICLs, photons are generated in optical transition between conduction and valence bands, in which the carrier lifetime is typically on the order of nanoseconds. This far longer carrier lifetime is a big deal – it allows the threshold current density in ICLs to be far lower than in QCLs. What's more, population inversion can be established without using fast multi-phonon-mediated depletion, resulting in a high voltage efficiency.

The superiority of the ICL over the QCL extends to the nature of its emission. The polarized output from an ICL is transverse electric, while that from a QCL is transverse magnetic. It means that it is possible to make interband cascade VCSELs. Such a device has already been demonstrated by researchers at NRL: they have made a $3.4\ \mu\text{m}$ interband cascade VCSEL operating in pulsed mode at temperatures of up to $70\ ^\circ\text{C}$.

So it is clear that ICLs have tremendous potential, combining the best attributes of diode lasers and QCLs. They promise to be the most efficient class of semiconductor mid-IR lasers, in terms of both power consumption and the threshold input power density.

Device design

ICLs are constructed by taking either GaSb or InAs substrates, loading them into an MBE chamber, and growing nearly lattice-matched heterostructures from the likes of InAs, GaSb, AlSb and their related alloys (see Figure 3, illustrating the unique variety of band alignments). In this material system, the conduction-band-edge of InAs is lower in energy than the valence-band-edge of GaSb, so this pairing of materials forms a semimetal-like hetero-interface – a unique feature in type-II broken-gap heterostructures and quantum wells. Another advantage of the broken-gap alignment is that it facilitates the efficient interband tunneling needed for re-using injected electrons within the device.

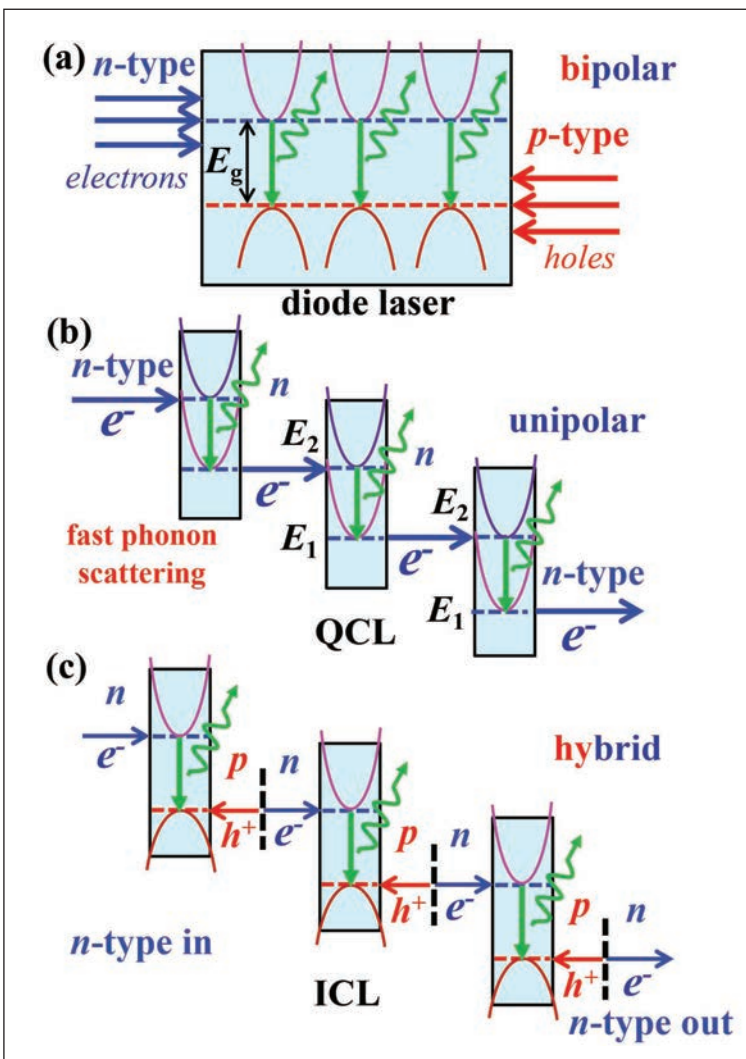

Figure 1. (a) conventional bipolar (electron and hole) diode laser; (b) unipolar intersubband QCL; (c) and an interband cascade laser (ICL) combining advantages of the first two. Note that the conduction and valence bands have opposite energy-wavevector dispersion relations, while sub-bands within the same conduction band have a similar energy-wavevector dispersion relationship.

In a typical type-II ICL, repeated active regions are separated by electron and hole injection regions, consisting of digitally graded InAs/AlSb and GaSb/AlSb quantum wells (see Figure 4). In each active region, containing InAs/GaInSb type-II quantum wells, optical transitions occur between the conduction states of InAs and the valence state of GaInSb, with wave-functions for the electrons and holes primarily residing in the respective layers.

To produce a high-performance ICL, engineers must ensure that the ground level for the electron in the InAs quantum well is positioned within the bandgap of GaSb. Doing this suppresses leakage current, because electrons injected into this section cannot directly tunnel out by the AlSb and GaSb layers. Instead, they undergo interband transitions to the valence state, thereby reaching the next stage.

After making this transition, the electrons travel through the valence band GaSb quantum well, before undergoing interband tunnelling, to arrive in the conduction band of the electron injector in the next cascade stage. Here, they are reused for additional photon emission.

One of the merits of the InAs/AlSb/GaSb material system is its large conduction and valence-band offsets, which ensure excellent carrier confinement. With this material system, the wavelength of the emission is controlled by simply adjusting the thicknesses of the type-II InAs and GaInSb quantum wells. Without changing constituent materials, emission wavelengths can span mid-infrared wavelengths from 2.5 μm to 12 μm . And even that's unlikely to be the longer-wavelength limit, given that type-II IC LEDs have produced electroluminescence beyond 15 μm .

Performance milestones

Since proposing the first ICL at *The 7th International Conference on Superlattices, Microstructures and Microdevices*, held in Banff, Canada in 1994 – the year of demonstration of the first QCL – this class of device has come on in leaps and bounds. Now these devices combine high-performance with wide wavelength coverage, which spans 2.7 μm to 11 μm for devices based on type-II quantum wells. Milestones for the ICL include: producing room-temperature operation

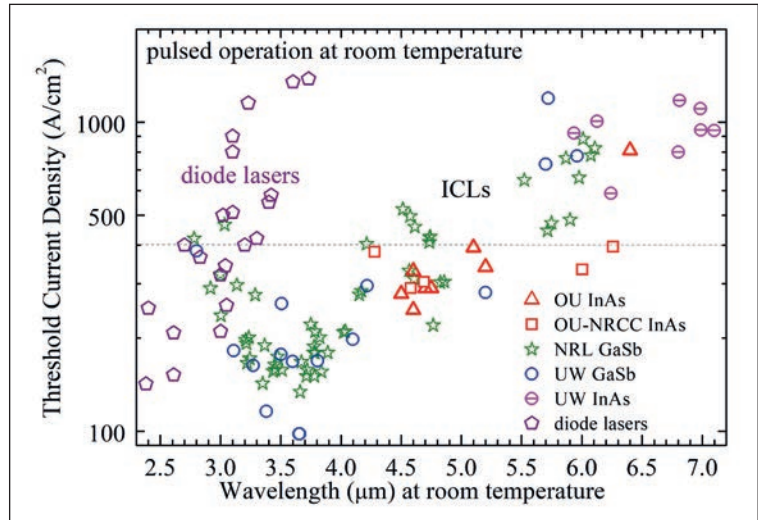

Figure 2. Pulsed threshold current density of conventional diode lasers from literature and type-II broad-area ICLs based on GaSb and InAs substrates at room temperatures (20-27 °C). ICLs were made at the Naval Research Laboratory (NRL), University of Wurzburg (UW), University of Oklahoma (OU) and National Research Council of Canada (NRCC).

with low threshold current densities at wavelengths spanning 2.7 μm to beyond 6 μm (see Figure 2); CW operation at temperatures of up to 115 °C; power consumptions less than 0.1 W, at threshold at 300 K; and CW output powers exceeding 500 mW.

Today GaSb-based ICLs, which led the development of this class of laser, are relatively mature in the 3-4 μm wavelength range. Much progress has also been made with InAs-based ICLs, which mainly cover wavelengths beyond 4 μm . Note that in the 4-6 μm region, InAs- and GaSb-based ICLs have comparable threshold current densities, but beyond 6 μm , InAs-based ICLs deliver a better device performance. However, it's important not to make any hard and fast rules. At longer wavelengths, GaSb-based and InAs-based ICLs have not been extensively investigated, and both types of laser have the potential for much improvement.

In this spectral range performance is hampered by significant Auger recombination and free-carrier absorption loss, as well as a reduction in gain that stems from a decrease in the wavefunction overlap

One of the merits of the InAs/AlSb/GaSb material system is its large conduction and valence-band offsets, which ensure excellent carrier confinement. With this material system, the wavelength of the emission is controlled by simply adjusting the thicknesses of the type-II InAs and GaInSb quantum wells.

Figure 3. Bandgaps, band-edge offsets and lattice constants of InAs/GaSb/AISb materials.

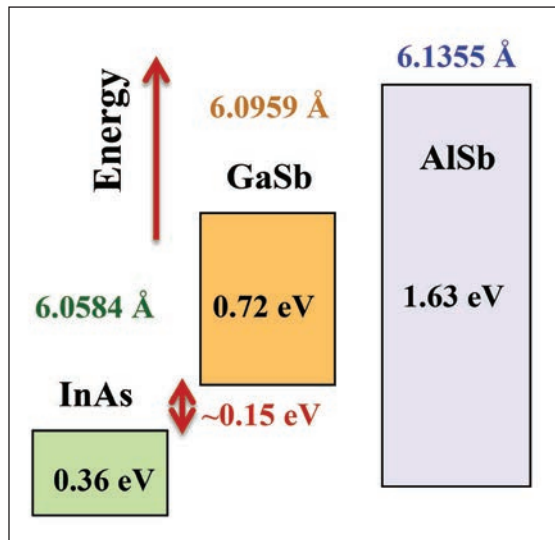
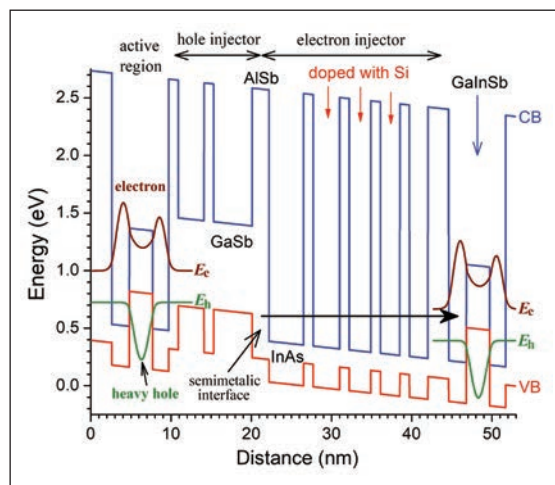

Figure 4. The layer sequence for an ICL, and conduction band (CB) and valence band (VB) edge profiles under forward bias.



between electron and hole states. With these factors at play, one might expect the lasing threshold current density to increase as the lasing wavelength approaches 7 μm and beyond (as is shown in Figure 2). However, it is premature to project where the boundary is, given the relatively modest increase in threshold current density with increases in the lasing wavelength from 4.3 μm to 6.3 μm .

The low threshold current densities in ICLs combine with low threshold voltages – typically between 2 V and 5 V – to produce a low threshold input power density. For emission in the 3 μm to 4 μm range, values can be as low as 0.35 kW/cm^2 (see Figure 5), which is an order of magnitude below the best QCL results. This validates the superiority of ICLs as energy-efficient mid-IR laser sources. They offer this attribute over a wide spectral range – type-II IC lasers, based on both GaSb and InAs substrates, can produce energy-efficient, CW operation at room temperature and above across a spectral range spanning 2.7 μm to 6.3 μm . With energy costs and environmental concerns destined to rise in the future, these energy-efficient ICLs are well-positioned to serve in many practical applications, such as portable instruments that could include battery-powered sensors in the field and network.

Equip the ICL with distributed feedback, and it can produce single-mode operation. This is enabling these lasers to be used for the detection of important molecules such as H_2CO , CH_4 , C_2H_6 , C_2H_4 , HCl , and CO . It is this application that has allowed the ICL to hit the headlines. A flight instrument aboard NASA's Curiosity rover, equipped with a distributed-feedback ICL, landed on Mars in August 2012 and has successfully detected methane. It is still working on Mars.

At longer wavelengths in the mid-infrared, ICLs are overshadowed by QCLs. Beyond 7 μm , QCLs are still delivering high performance at room temperature, while ICLs are yet to produce room-temperature operation. Innovation will be required to overcome this barrier, but there is hope – ICLs have exhibited threshold current densities of just 2-10 A/cm^2 at 80K, with little sensitivity to the lasing wavelength over 3-10 μm . Combining these low current densities with a low threshold voltage of typically 2-5 V leads to a very low power consumption for ICL narrow-ridge lasers – it can be below 10 mW at 80K.

Such a low power consumption is a major asset in applications requiring devices with highly sensitive, low-noise detectors at long wavelengths. In such scenarios, the detectors have to be cooled to minimise noise, so a cooling platform is readily available – and if the power consumption of the ICL is less than 10 mW, that is not much of a burden on the cooling environment. In other words, it is feasible to add an efficient ICL, to create a significant energy saving. Ultimately, this could enable more applications, thanks to a reduced system size and cost.

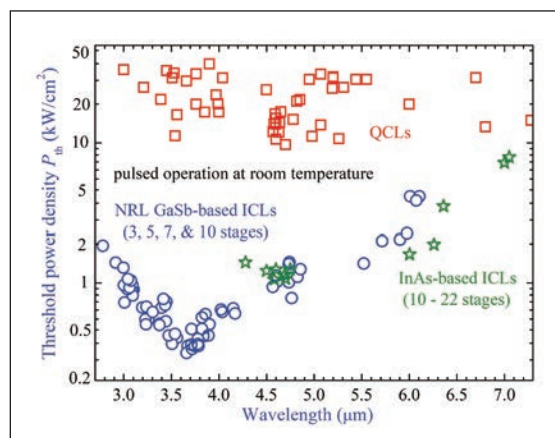

Figure 5. Threshold input power density for room temperature QCLs and ICLs.

Commercialisation of ICLs

There are now three companies producing and selling ICLs: nanoplus in Germany; Thorlabs in the US; and the Swiss company Alpes Lasers, which has licensed NRL patents. In addition, several research institutions are developing ICLs, including NRL, University of Oklahoma, University of Wurzburg, National Research Council of Canada, the University of Montpellier, and Institute of Semiconductors at Chinese Academy of Sciences. In comparison, far more firms and groups are working on QCLs, partly because the antimonide-based III-V material system and related device fabrication technology are less mature – and also because there are limited resources for growing these heterostructures.

Interband cascade bandwagon

Uses of the interband cascade structures are not limited to efficient mid-infrared lasers. This class of heterostructure can also be used to make high performance mid-infrared LEDs, as well as photodetectors and photovoltaic cells that convert mid-infrared light into electricity. Preliminary efforts have demonstrated high-performance, room-temperature IC infrared photodetectors with cut-off wavelengths spanning 3 μm to 12 μm , and promising IC thermophotovoltaic cells. These results underscore the feasibility of integrating different functional devices on the same chip – and approach that could lead to miniaturised mid-infrared modules and systems.

Our team at the University of Oklahoma is developing this type of technology. We have monolithically integrated an ICL and detector (see Figure 6). This device has an open-circuit voltage of 1.06 V, which is nearly three times the bandgap, indicating the highly effective action of cascade. Peak detectivity is 1.9×10^{10} Jones at 20 $^{\circ}\text{C}$, the highest reported value for mid-infrared detectors at room temperature.

This survey of interband cascade devices, and lasers in particular, shows that this technology is clearly making a transformative change to the mid-infrared landscape with much progress. The coming years are sure to witness further improvements in performance and more expansion to less explored or even new aspects such as frequency combs, highlighting the capability of this class of device for serving the mid-infra-red.

Further reading

R. Q. Yang, "Interband Cascade (IC) Lasers", Chap. 12, in *Semiconductor lasers: Fundamentals and applications*, edited by Baranov and E. Tournie (Woodhead Publishing, 2013)

I.Vurgaftman *et al.* J. Phys. D: Appl. Phys. **48** 123001 (2015); Encyclopedia of Analytical Chemistry (2016)

J. Koeth *et al.* Proc. SPIE 10403 1040308 (2017)

S.M.S. Rassel *et al.* Opt. Eng. **57** 011021 (2018)

W. Huang *et al.* Infrared Phys Technol. **96** 298 (2019)

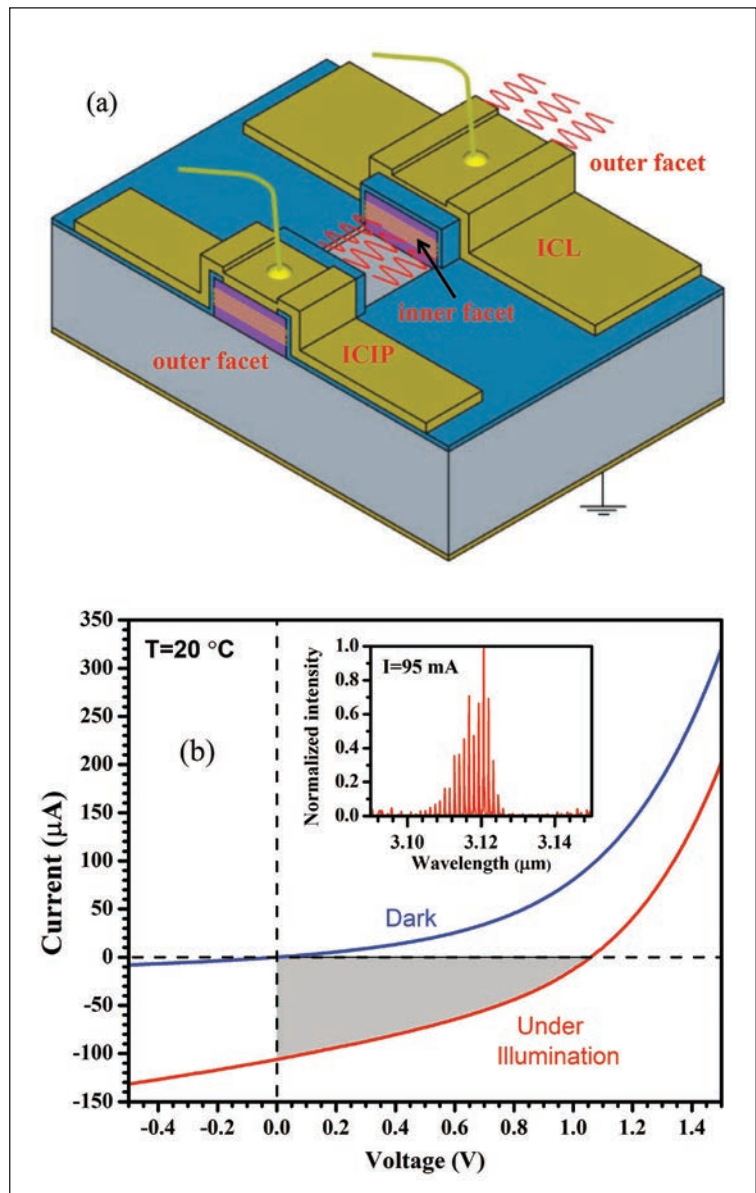

Figure 6. (a) An interband cascade laser and detector. (b) The current-voltage characteristics for the detector under dark and laser illumination. Inset shows the laser emission spectrum from the outer facet.

Dots and wells

deliver lasing on silicon

Spurring the development of silicon photonics is the world's first InP-based laser grown on exactly orientated silicon

BY KEI MAY LAU AND YU HAN FROM HONG KONG UNIVERSITY OF SCIENCE AND TECHNOLOGY

WE ARE LIVING in a zettabyte era, where digital data is generated, processed, stored, and transmitted at unprecedented rates. Demand for data is only going to increase, and satisfying this will not be easy. However, it can be fulfilled by silicon photonics, drawing on cost-effective microelectronics technologies to realize ultra-high-bandwidth, power-efficient photonics on the traditional silicon platform.

An essential but elusive component for silicon photonics is a compact, efficient, on-chip

semiconductor light source. For the past decade, the development of this source has focused on heterogeneous integration – that is, the bonding of conventional III-V semiconductor laser dies onto silicon photonic wafers. This hybrid integration technique is not as attractive as monolithic integration, involving the direct growth of III-V lasers on silicon. But realising the latter is more challenging, partly because in order to ensure compatibility with present IC technology, lasers must be integrated on CMOS-standard (001)-oriented silicon substrates without

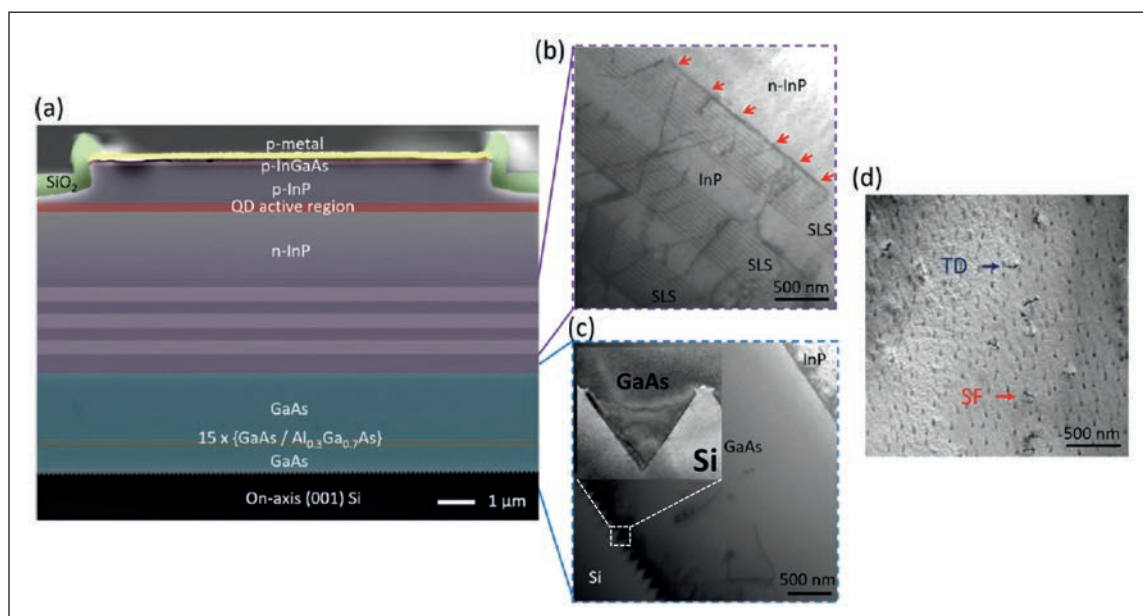

Figure 1. (a) Colour-enhanced cross-sectional scanning electron microscopy image of the whole epitaxial structure after laser fabrication. (b) Cross-sectional transmission electron microscopy images of three stacks of a 10-period InGaAs/InP strain-layer superlattices with dislocation filtering effects identified by red arrows. (c) 2.2 μm -thick GaAs intermediate buffer on a nano-patterned V-grooved on-axis (001) silicon substrate; inset shows the defect trapping effect of the tiara-shaped pocket enclosed by {111} facets. (d) Plan-view transmission electron microscopy characterization of defect density of the InP buffer on silicon.

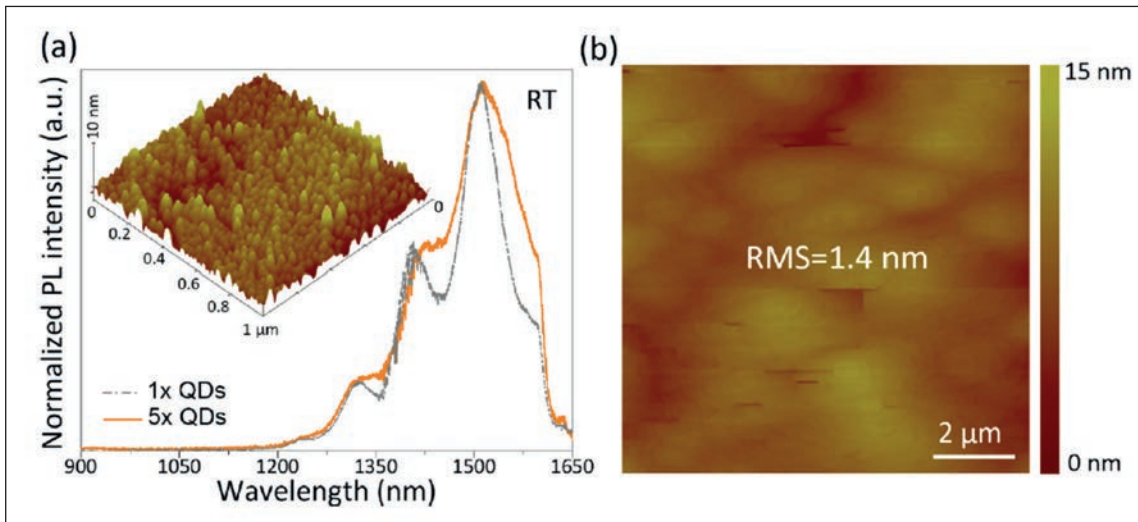

Figure 2. (a) Normalized room-temperature photoluminescence spectra of 1 and 5 layers of quantum dot active regions grown on silicon. Inset shows an atomic force microscopy image of the top layer quantum dots with a dot density of $4.5 \times 10^{10} \text{ cm}^{-2}$. (b) Atomic force microscopy image of the as-grown quantum dot laser on silicon, showing a smooth surface with a root-mean-square value of 1.4 nm.

an offset. The offset (mis-orientation) was deemed necessary to overcome the anti-phase boundary defects formed when growing polar semiconductors (III-V) on non-polar silicon. What's more, as the ICs will be used in data communications, these lasers must operate at telecommunication wavelengths – the 1.3 μm and 1.5 μm band. And if this approach is to be commercially successful, the lasers that are produced

must deliver a high performance, and be coupled with other silicon photonics components in a scalable, cost-effective manner.

At Hong Kong University of Science and Technology, we can address most of these concerns with a technology that enables direct hetero-epitaxy of III-V coherent lasers on silicon substrates. This approach,

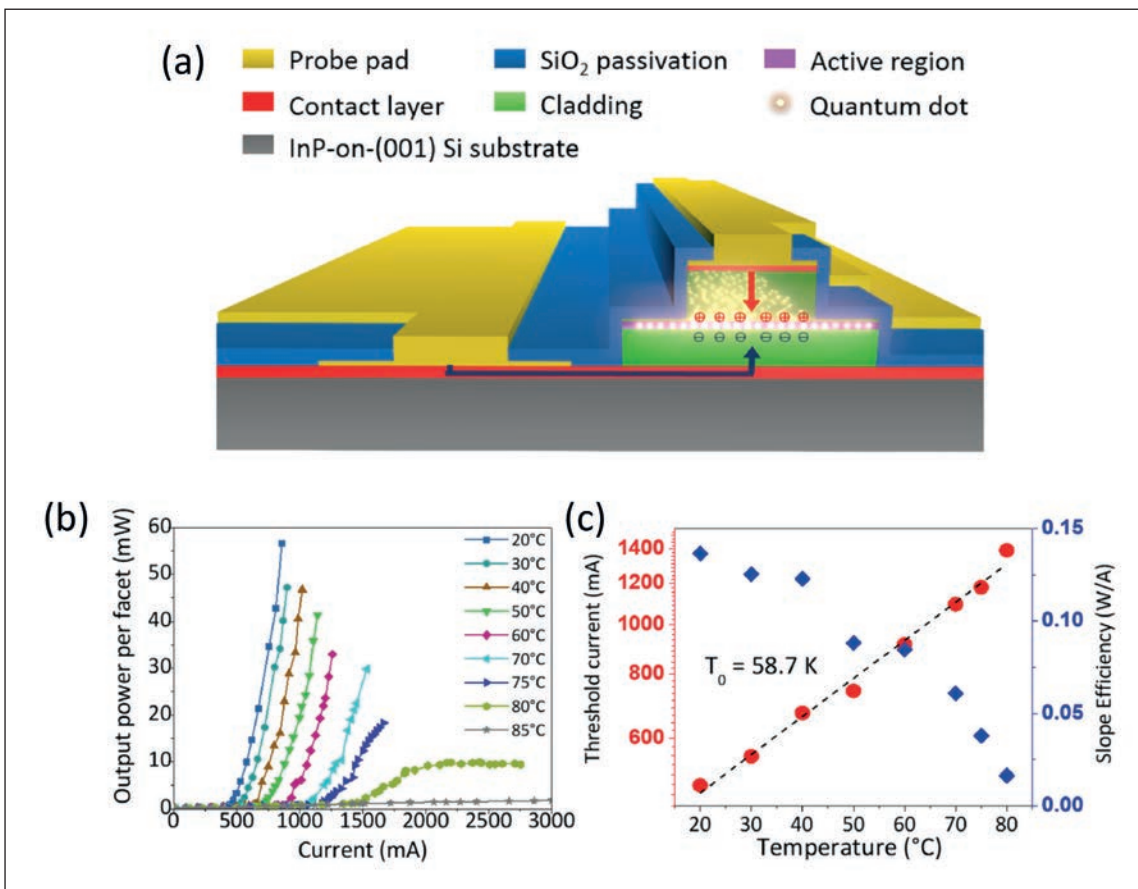

Figure 3. (a) Schematic of an InAs/InAlGaAs/InP quantum dot laser on silicon substrates. (b) Light output power versus current for a $20 \mu\text{m} \times 1000 \mu\text{m}$ device at various temperatures. (c) Threshold current and slope efficiency change as a function of temperature. The characteristic temperature is extracted to be 58.7 K.

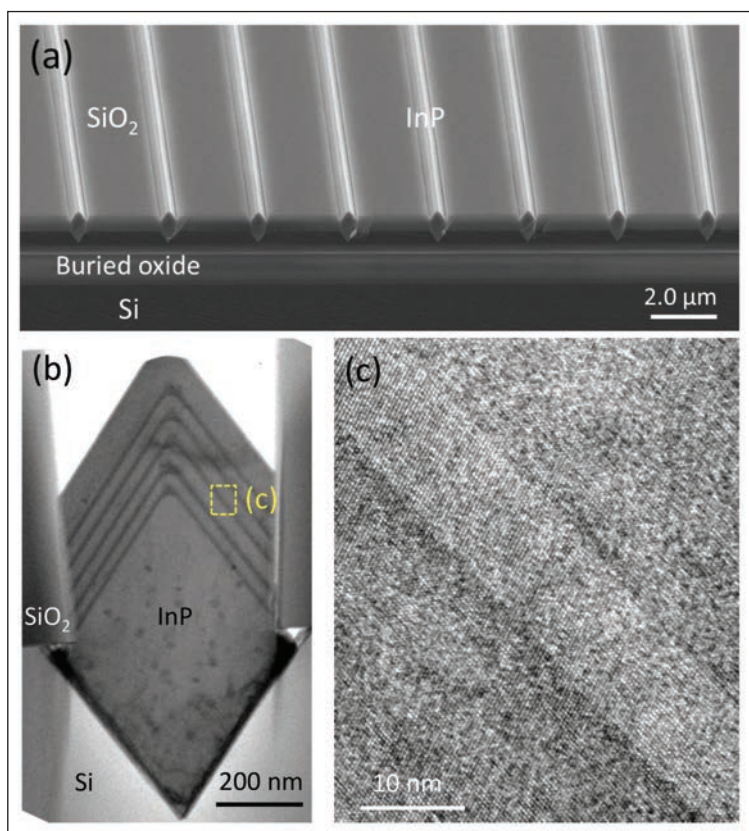

Figure 4. (a) Scanning electron microscopy image of the highly ordered, in-plane InP/InGaAs nano-ridge structures on (001) silicon-on-insulator wafers. (b) Cross-sectional transmission electron microscopy image of the InP/InGaAs nano-ridge perpendicular to the wire, showing five {111} ridge InGaAs quantum wells embedded inside an InP nano-ridge; the dark area at the InP/silicon interface contains a high density of stacking faults generated for strain relaxation. (c) High-resolution transmission electron microscopy image of one InGaAs ridge quantum well with atomic sharp InP/InGaAs interfaces.

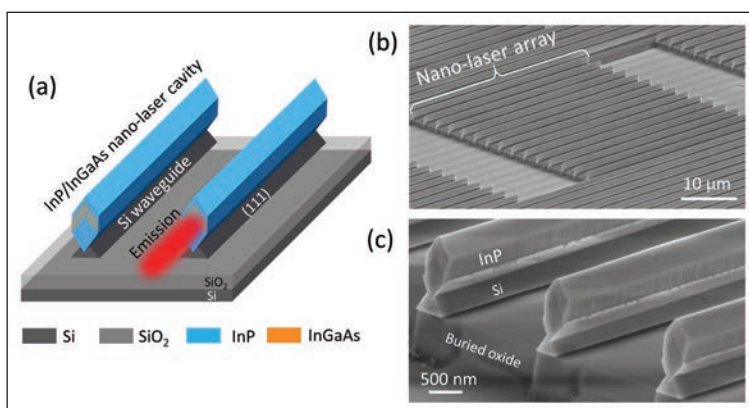

Figure 5. (a) Schematic of the designed InP/InGaAs nano-laser array grown on an SOI substrate. (b) Tilted-view scanning electron microscopy image of the InP/InGaAs nano-laser array on SOI. (c) Zoomed-in scanning electron microscopy image of the end-facets of the nano-laser array.

involving MOCVD, offers the potential for lower cost, higher yield, and scalability than chip-scale bonding.

One of the challenges of direct growth is how to address the polarity and lattice mismatch between the III-Vs and silicon. Crystalline defects emerge from the III-V/silicon interface, including various kinds of dislocations, and they can jeopardize laser performance and reliability. Special techniques are required to suppress the generation and propagation of these dislocations, and enable efficient light emission on silicon substrates. We are pioneering one promising solution, based on low dimensional In(Ga)As quantum structures. By embedding quantum dots inside optimized InP buffer layers that are grown on silicon substrates, we are able to use MOCVD to produce 1.5 μm-band InP-based lasers on industry-standard silicon wafers.

Quantum dot lasers on silicon

Fabrication of our lasers begins with the growth of III-V alloys on 300 mm nano-patterned silicon wafers. This involves a unique patterned growth process on exact (001)-oriented silicon substrates, rather than 2-6° offcut silicon, the platform adopted by many other groups (see Figure 1(a)). Our efforts begin by creating [110]-aligned oxide trenches atop the silicon wafer. Anisotropic wet etching follows, to obtain densely packed V-shaped pockets with two concave, atomic-sharp {111} surfaces. By nucleating GaAs inside these nano-pockets, we eliminate the formation of anti-phase boundaries – a crystalline defects that is detrimental to devices. We find that GaAs nanowires first nucleate inside the nano-pockets that coat the {111} surfaces. Continued growth leads coalescence, creating thin films. Thanks to the unique tiara-shape of the nano-pockets, we find that the planar defects generated at the interface of GaAs and silicon are unable to propagate into the above heterostructures (see Figure 1(c)).

Our next step is to grow an InP layer on the coalesced thin film of GaAs. Due to the 4 percent lattice mismatch between InP and GaAs, dislocations appear at the interface between these two materials. To prevent them from propagating into device regions, we insert ten periods of $\text{In}_{0.6}\text{Ga}_{0.4}\text{As}$ /InP strain layer superlattices inside the InP buffer. The strain inside these superlattices changes the propagation direction of the dislocations, causing them to either annihilate or propagate to the edge of the sample (see Figure 1(b)).

We have scrutinised the quality of our material with transmission electron microscopy. This reveals a defect density of $1.5 \times 10^9 \text{ cm}^{-2}$, which is one of the lowest values reported for an InP thin film grown on silicon (see Figure 1(d)). We believe this is not the limit, and are currently exploring new methods to further reduce the defect density.

On this foundation we deposit several layers of quantum dots. These nanostructures, which

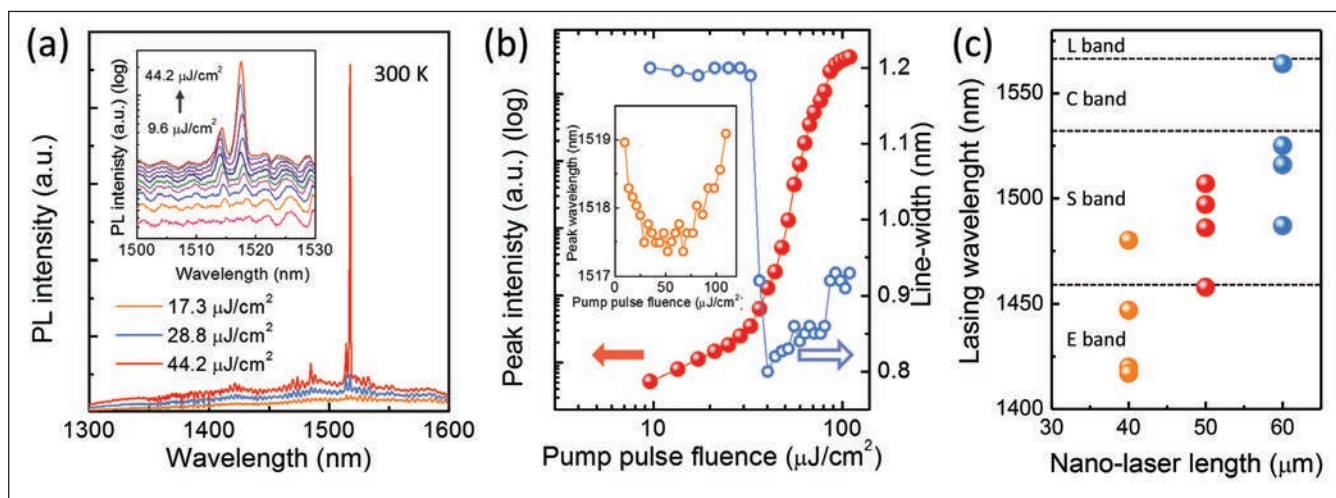

Figure 6. (a) Room-temperature emission spectra around threshold. Inset shows the emission spectra plotted in a logarithmic scale. (b) The evolution of the peak intensity and the line-width as the excitation level increases. Inset presents the progression of peak position as a function of pumping levels. (c) The relationship of the lasing peak and the length of the nano-cavity.

support strong quantum confinement and have a delta-function-shaped density of states, promise to enhance laser performance, in terms of lasing threshold, maximum modulation frequency and temperature stability. What's more, quantum dots have a superior tolerance to dislocations, thanks to a three-dimensional confinement of charge carriers. This fine set of attributes make an array of quantum dots the ideal choice for the active gain medium for lasers grown on silicon.

To see if they can fulfil their promise, we have embedded five layers of InAs quantum dots inside a laser structure on the InP buffer. Each of the layers of dots, formed using the Stanski-Krastanow growth mode, is capped with two layers of optimised InAlGaAs spacers. They have a thickness that has been carefully tuned to ensure a strong, narrow photoluminescence spectra.

Atomic force microscopy reveals that our samples have a quantum dot density of $4.5 \times 10^{10} \text{ cm}^{-2}$ (see Figure 2 (a)). This technique has also evaluated the flatness of the surface of the full laser structure. It has a surface roughness of just 1.4 nm (Fig. 2(b)). Meanwhile, photoluminescence measurements produce a strong peak centred at the 1.5 μm band (see Figure 2(a)).

We have used this heterostructure to produce the world's first electrically injected 1.5 μm quantum dot laser that is directly grown on silicon. This success has hinged on combining our low-defect InP templates with optimised InAs quantum dots. These lasers, in the form of Fabry-Pérot bars, have end-facets formed by cleaving, and dimensions of 5 mm by 10 μm . Driving these devices with pulses produces a room-temperature output power in excess of 110 mW. The

threshold current density is 1.6 kA cm^{-2} , equating to 320 A cm^{-2} per quantum dot layer. Operation is possible up to 85 $^{\circ}\text{C}$, and the characteristic temperature is 59 K (see Figure 3).

This result is an important step towards our goal of equipping silicon photonic chips with efficient light emitters, in the form of high-performance 1.5 μm quantum dot lasers directly grown on silicon. Right now, we are targeting continuous-wave operation, a goal that we hope to accomplish by reducing the dislocation density of the InP-on-silicon template, improving the quantum efficiency of InAs quantum dots, and optimising the overall laser structure.

Lasers at the nano-scale

Our efforts have also focused on the direct epitaxy of 1.5 μm InP-based nano-lasers on silicon substrates. Like the scaling of silicon transistors, as governed by Moore's Law, the shrinking of the laser footprint to nanometre scale delivers several benefits. In this case it cuts energy consumption, while increasing the integration density of silicon photonic integrated circuits.

The starting point for the creation of our nano-lasers, featuring InP nano-ridges, is nano-patterned, (001)-oriented, silicon-on-insulator (SOI) substrates. Using the aspect ratio trapping technique, we begin by depositing an ultra-thin GaAs wetting layer – it is around 10 nm-thick – at the {111} silicon surface, to facilitate subsequent InP nucleation. With this approach we can confine most of the crystalline defects within the III-V/silicon interface, due to the unique strain-relaxing mechanism (see Figure 4(b)).

The resulting as-grown InP nano-ridges, which have a width of 450 nm and a height of 1.0 μm , develop

a convex growth front. Two large {111} facets and one tiny (001) facet form inside the oxide trenches. This lack of uniformity is a nuisance, complicating the insertion of lattice-matched InGaAs quantum structures. That's because the ternary InGaAs alloy tends to exhibit different chemical compositions at different facets. Due to this compositional inhomogeneity, the photoluminescence spectra is broad and multi-peaked.

Our solution is cycled growth. This allows us to manipulate the distribution of InGaAs on the multi-faceted InP ridge buffer at a single-atomic-layer level. As a result, we can grow InGaAs quantum wells with atomic sharp interfaces and superior optical properties (see Figure 4(c)).

Aiming at developing nano-scale photonic integrated circuits on SOI, we are now focusing on the design of electrically driven nano-lasers on SOI wafers. Look out for our future publications, as we are confident that we will soon have more promising results to report.

One of the key challenges with nano-lasers on silicon is the confinement of the optical modes within the sub-wavelength nano-cavities. We improve the confinement with a hybrid InP/InGaAs Fabry-Pérot nano-cavity design that is supported by silicon pedestals (see Figure 5(a)). The silicon pedestal is formed via anisotropic wet etching, with the dimensions carefully controlled to ensure both strong optical confinement inside the nano-ridge and robust mechanical support for the top laser cavity (see Figure 5 (b) and 5 (c)). The silicon pedestal, which features atomically sharp {111} surfaces, could also serve as a low-loss waveguide. This structure could couple light from the laser cavity above, providing potential on-chip light manipulation.

In sharp contrast to the commonly reported vertical nanowire lasers – they have a cavity length that is governed by the growth parameters and is normally shorter than 10 μm – our horizontally-aligned InP nano-cavity, which is defined by lithography, has a length that can vary from a few microns to hundreds of microns. Another merit of our technology is that thanks to the in-plane configuration of nano-lasers

on SOI wafers, our devices can be integrated with other silicon-based photonic components, including waveguides, splitters and (de)multiplexers that are also processed on SOI substrates.

Optical pumping

Measurements on our laser with a 60 μm cavity reveal that optical pumping produces room-temperature lasing in the 1.5 μm band. Under low excitation, the output from the nano-laser combines broad spontaneous emission with well-spaced Fabry-Pérot resonance peaks. Crank up the pumping, and a 1518 nm peak protrudes from the background emission, before lasing kicks in. Far above threshold, the intensity of the 1518 nm single-lasing-mode is orders of magnitude higher than the clamped background emission. Further support for lasing is the apparent threshold behaviour in the plot of output with pump power, and the line-width narrowing of the emission peak (see Figure 6(b)).

By varying the length of the cavity, we can produce lasers with different emission wavelengths from the same epiwafer. For example, increasing the length of the cavity from 40 μm to 60 μm can shift the dominant lasing mode from 1400 nm to 1550 nm.

This correlation between the lasing mode and the cavity length stems from the wavelength-dependent modal gain and propagation/end-facet loss. As a longer wavelength leads to a larger round-trip loss and a smaller modal gain, a larger volume of active material is needed to reach threshold. The opportunity to tune the lasing wavelength over multiple telecom bands suggests that our technology could serve in compact wavelength-division multiplexing systems.

Our incorporation of a telecom nano-laser array onto CMOS-compatible, (001)-oriented SOI substrates highlights the feasibility of on-chip integration between compact III-V nano-scale light sources and mature silicon photonic components. Aiming at developing nano-scale photonic integrated circuits on SOI, we are now focusing on the design of electrically driven nano-lasers on SOI wafers. Look out for our future publications, as we are confident that we will soon have more promising results to report.

Further reading

- Q. Li *et al.* Appl. Phys. Lett. **106** 072105 (2015)
- S. Zhu *et al.* Appl. Phys. Lett. **113** 221103 (2018)
- Y. Han *et al.* Appl. Phys. Lett. **108** 242105 (2016)
- Y. Han *et al.* Optics Letters. **44** 767 (2019)

Refining the sodium-flux method

Eliminating oxygen improves the quality of GaN seeds

Low-cost, large-diameter GaN substrates are widely considered to be the best foundation for producing blue and green lasers and GaN power devices.

The production of such substrates has remained elusive, but they now appear to be tantalisingly close, thanks to a breakthrough by researchers at Osaka University, Japan.

For many years, this team have been pioneering the growth of GaN substrates by the sodium-flux technique, and they can now produce material with a very low threading dislocation density. However, the growth process is incredibly slow – it is less than 50 $\mu\text{m/hr}$ – so more recently, these researchers have

pursued a hybrid approach, combining this technique with HVPE. The idea is that the sodium-flux method creates high-quality seeds, before HVPE thickens them with growth rates of more than 1 mm/hour.

Hampering this progress has been the high levels of oxygen in the pyramidal facets of the multi-point seeds. This must be addressed, because oxygen causes lattice mismatch, leading to material degradation, such as cracking and dislocations.

When they started trying to tackle this issue, the researchers attempted to use high-temperature growth to cut oxygen contamination in the pyramidal facets. As this didn't deliver a sufficient reduction in oxygen contamination, they realised that it would be necessary to suppress facet growth and promote c-plane growth. The breakthrough, just realised, is to use the residual Ga-Na melt formed along the pyramidal GaN crystals. This enables nitrogen-rich crystal growth.

The latest process begins by patterning a GaN film grown on a sapphire wafer. In their paper, the team describe results obtained on a patterned 5 μm -thick film of GaN, grown on a 3-inch sapphire substrate.

Growth by the sodium-flux method begins by holding the patterned wafer over the Ga-Na melt for 24 hours, until it becomes supersaturated with nitrogen. The wafer is then dipped in the melt for 30 hours (see Figure 1). Extracting the substrate reveals the residual flux among the pyramidal GaN crystals.

To produce a planar film, the patterned wafer is repeatedly dipped in the melt, to address the short supply of sodium in the thin flux. This creates a completely flat c-plane film after 100 hours. Then, to increase thickness once more, the researchers dip the GaN in the melt for a further 100 hours. On cooling, GaN naturally separates from sapphire without cracking (see Figure 2).

Due to a patent application, the team did not include results on HVPE growth on the GaN in their paper, but 1 mm-thick growth has been realised, according to team spokesman Masayuki Imanishi.

The next goals for the team include the fabrication of GaN wafers with a 100 mm diameter, and the growth of GaN films by HVPE that are over 5 mm-thick.

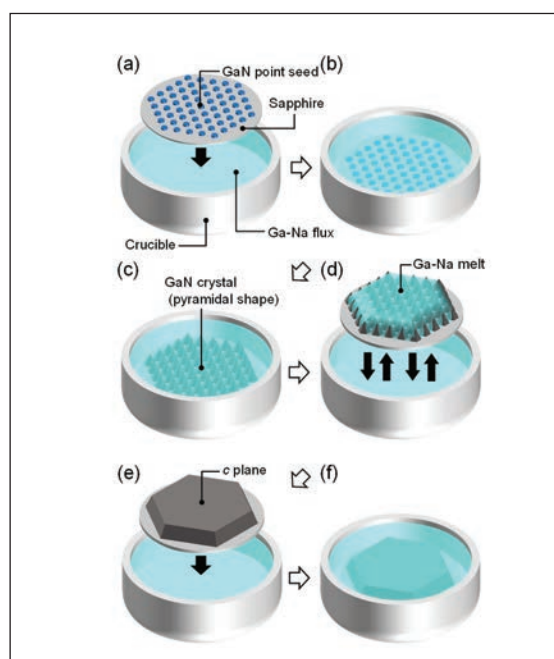

Figure 1. Dipping of the point seeds initiates the growth of GaN ((a) to (c)), before further dipping yields a flat film (d), that is then thickened ((e) and (f)).

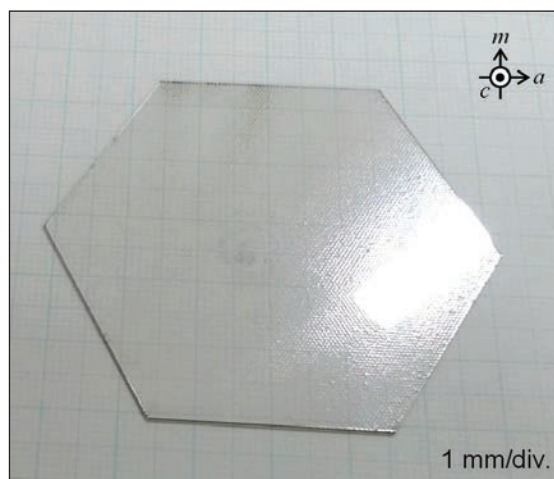

Figure 2. GaN produced by the refined sodium-flux method. This material, which has been backgrinded and polished, is more than 2-inch in diameter, and has a threading dislocation density that varies from 10^3 cm^{-2} to 10^5 cm^{-2} .

Reference

M. Imanishi *et al.* *Appl. Phys Express* **12** 045508 (2019)

Narrowing the linewidth of the green laser

A distributed feedback grating enhances the spectral purity of the green, nitride-based laser

RESEARCHERS from King Abdullah University of Science and Technology, Saudi Arabi, claim to have produced the first InGaN-based green laser with a distributed feedback (DFB) grating.

The addition of this grating creates a single-wavelength source that could benefit sensing, atomic clocks, and underwater wireless optical communications, according to the team spokesman Boon Ooi.

“These green DFB lasers could be matched with low-background-noise lines of the solar spectrum, also known as Fraunhofer lines, improving the signal-to-noise ratio of environmental sensors and visible light communications,” says Ooi.

According to him, these green sources could also improve atomic clock technology, by enabling the development of new designs based on unexplored atomic transitions.

“Additionally, green DFB lasers are expected to be suitable for fast modulation while being matched to the lowest light-absorption levels in coastal and turbid waters,” explains Ooi. Due to these merits, the DFB green laser is a promising source for underwater wireless optical communication.

Ooi and his co-workers inserted a DFB grating in a commercial laser that they had to hand – it happened to be one from Osram. “We used an off-the-shelf laser diode, demonstrating that narrow-line green laser diodes using integrated DFB gratings can be readily implemented,” explains Ooi.

He and his colleagues did not add a buried grating, arguing that this requires overgrowth, which tends to compromise material quality. Instead, they formed a 40th-order surface grating using a focused ion beam.

Forming a grating in this way is ideal for rapid implementation, but is unsuitable for high-volume manufacture. To produce green DFB lasers in high quantities, Ooi recommends processes such as UV photolithography and electron-beam lithography.

The researchers produced their device by adding a DFB laser to an Osram PLP520, a chip with a 4 μm -

wide ridge waveguide and a 0.9 mm-long cavity. Driven at 300 mA, this device produces 141 mW.

Adding a DFB grating with a period of 4.114 μm created a narrow-wavelength source. Driven at a 300 mA drive current, this device had a spectral width – defined in terms of the full-width at half maximum – of just 31 pm, and a side-mode suppression ratio of 36.9 dB. According to the team, for an InGaN-based laser, this is the highest value ever reported for the side-mode suppression ratio.

The downside of adding a grating is the substantial reduction in output power. This fell to just 14 mW at 300 mA. The team attributes this sharp decline, and the substantial fall in external quantum efficiency from 20.7 percent to 3.5 percent, on a degradation in optical performance.

Higher output powers and efficiencies should result from optimisation of the ridge width and length, the grating order etching depth, and the passivation process.

Ooi and his colleagues are now starting to develop lower-order DFB gratings, as well as wafer-scale fabrication, targeting a narrower linewidth.

“We are also testing our DFB lasers at the system level in communications and other applications,” says Ooi.

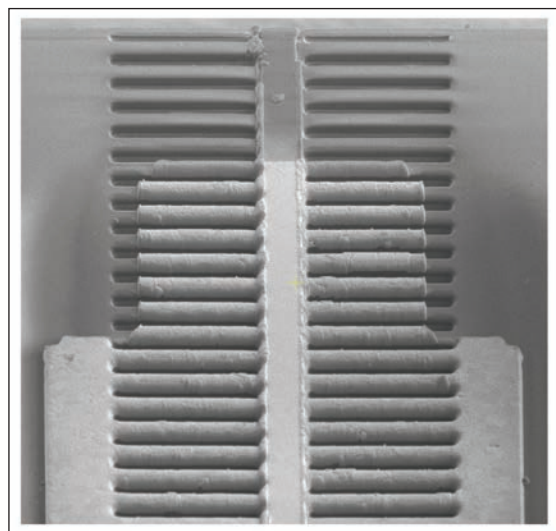

Engineers at King Abdullah University of Science and Technology have produced a green laser with a narrow linewidth by adding surface gratings to a commercial laser.

Reference

J. A. Holguin-Lerma *et al.* *Appl. Phys. Express* **12** 042007 (2019)

Cubic GaN: a solution to the green gap?

Switching from hexagonal to cubic GaN could create more efficient green LEDs with reduced droop

STRONG INTERNAL ELECTRIC FIELDS and an inferior material quality are to blame for the low efficiency of green LEDs. Their efficiency is less than half of that of their red and blue cousins.

Addressing this issue, known as the green gap, is not easy – but turning from the conventional hexagonal phase to the cubic variant offers much promise, according to first-principles calculations made by a Yi-Chia Tsai and Can Bayram from the University of Illinois at Urbana-Champaign.

These calculations reveal that the merits of the cubic phase, compared to the hexagonal one, include smaller bandgaps, smaller lattice mismatches and smaller effective masses.

“Specifically, green emission through cubic III-nitrides can be achieved with five percent less indium content in the quantum wells than what is needed in hexagonal ones,” says Bayram.

Reducing the indium content is an important breakthrough, as it leads to a decrease in lattice mismatch, lower defectivity and better material quality.

“Five percent less indium is significant, considering the exponential temperature behaviour of indium incorporation,” says Bayram, who points out that this enables a higher growth temperature for green-emitting quantum wells, increasing the uniformity of the alloy in these layers.

A switch to cubic InGa₂N also holds the key to improving the design of the active region. In conventional devices, wells must be no more than just a few nanometres thick. This ensures sufficient overlap between the electrons and holes, which are pulled in different directions by the internal electric fields.

The downside of thinner wells is that they are less efficient at capturing carriers. To address this, several quantum wells are stacked on top of one another, but this impairs device performance, due to carrier injection asymmetry. Only the wells nearer the *p*-type region emit, due to electron overflow.

With cubic LEDs, the device is free from piezoelectric effects, so no strong fields are pulling electrons and holes apart. This means that the radiative recombination efficiency is high, even for thick quantum wells that increase carrier capture. What's more, LEDs made from this form of GaN suffer from less Auger recombination, so are less prone to droop.

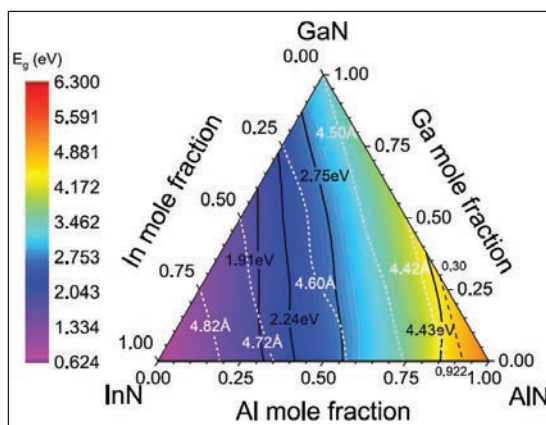

It should be noted that the duo from the University of Illinois at Urbana-Champaign are by no means the first to undertake calculations on the key characteristics of GaN and its related alloys. There have already been calculations based on the local-density approximation, the generalised gradient approximation, and the ‘ G_0W_0 ’ approximation. According to Bayram, the downside of all these approaches is that they lead to contradicting results. For example, values for the bandgap of *h*-phase InN range from 0.69 eV to 1.02 eV and 2.0 eV, while the widely accepted experimental value is 0.78 eV.

“In our work, we use collaboration with experimentation to validate hexagonal III-nitride findings, and then apply this theoretical methodology for extracting the cubic phase parameters,” says Bayram. This unified methodology is claimed to offer higher accuracy in quantifying the structural and electronic properties of indium-rich III-nitrides.

Bayram and Tsai use a variation of the local-density approximation, because the standard versions underestimate the bandgap. They employ a form known as the LDA-1/2, which considers half-ionising of the electron, and corrects the value for the bandgap.

Using this approach, the researchers found that to realise green emission at 550 nm in the *h*-phase required a composition $\text{In}_{0.322}\text{Ga}_{0.678}\text{N}$, but for the *c*-phase, it is accomplished with $\text{In}_{0.274}\text{Ga}_{0.726}\text{N}$.

The researchers will now simulate the optical, electrical and thermal behaviour of cubic-phased devices.

Cubic nitrides are mostly direct bandgap. The black dashed line in the high-aluminium-content region marks the direct-indirect transition. White dashed lines are lattice constant isolines. Black solid lines are bandgap isolines of common emitters: red (1.91 eV, 650 nm), green (2.24 eV, 550 nm), blue (2.75 eV, 450 nm), and UV (4.43 eV, 280 nm).

Reference

Y. -C. Tsai *et al.* *Sci. Rep.* **9** 6583 (2019)

AIXTRON

Tel: +49 2407 9030 0
 Fax: +49 2407 9030 40
 Email: info@aixtron.com
 www.aixtron.com

Non Contact Measurements
 Resistance, Resistivity
 Wafer Thickness

KITEC
 microelectronic technologie

Tel: +49 (0)8122 86676
 Fax: +49 (0)8122 86652
 Email: info@kitec.de
 www.kitec.de

Temescal

Tel: +1 925 245 5817
 Fax: +1 925 449 4096
 Email: lwarren@ferrotec.com
 www.temescal.net

EPIGAN
 AHEAD IN GAN SOLUTIONS

Email: info@epigan.com
 www.epigan.com

Fil-Tech

Tel: + 1 617-227-1133
 Fax + 1 617-742-0686
 Email: paula@filtech.com
 www.filtech.com

Veeco

Tel: 516-677-0200-1222
 Fax: 516-714-1231
 Email: jpina@veeco.com
 www.veeco.com

ULVAC

Tel: +49-89-96090900
 Email: ulvac@ulvac.de
 www.ulvac.eu

VACUUM BARRIER VBC CORPORATION

Tel: +1-781-933-3570
 Email: sales@vacuumbarrier.com
 www.vacuumbarrier.com

nel

Tel: + 1 203 949 8697
 Email: info@nelhydrogen.com
 www.nelhydrogen.com

INNOVION
 FOUNDRY ION IMPLANTATION

Tel: +1 408 501 9100
 Fax: +1 408 501 9110
 Email: sales@innovioncorp.com
 www.innovioncorp.com

PARTICLE MEASURING SYSTEMS
 a spectris company

Tel: +1 303.443.7100
 Email: info@pmeasuring.com
 www.pmeasuring.com

TYSiC
 1st SiC-epi Foundry in China

Tel: 86-769-2289 3350
 Fax: 86-769-2289 3355
 Email: enquiry@sicty.com
 www.sicty.com

III/V-Reclaim GaAs InP

Tel: +49 8728 911 093
 Fax: +49 8728 911 156
 Email: sales@35reclaim.com
 www.35reclaim.de

MASIMO
 semiconductor

Tel: +1 603 595 8900
 Email: sales@masimosemi.com
 www.masimosemiconductor.com

UMC UNITED MINERAL & CHEMICAL CORP.
 MBE Specialists

Tel: +1 201 507 3300
 Fax: +1 201 507 1506
 Email: inquiry@umccorp.com
 www.umccorp.com

kSA
 k-Space Associates, Inc.

Tel: +1 734-426-7977
 Email: requestinfo@k-space.com
 www.k-space.com

CS CLEAN SOLUTIONS

Tel No: +49 (89) 96 24 00-0
 Fax No: +49 (89) 96 24 00-122
 Email: sales@cs-clean.com
 www.cs-clean.com

Engis
 World Leader in Superabrasive Finishing Systems

Tel: +1 847 808 9400
 Email: info@engis.com
 www.engis.com

evatec
 process systems

Tel: + 41 81 403 8000
 Fax: + 41 81 403 8001
 www.evatecnet.com

Vistec
 Electron Beam

Tel: +49 (0) 3641 79980
 Fax: +49 (0) 3641 7998222
 www.vistec-semi.com

Sanan Integrated Circuit Co., Ltd.

Tel: +1 949 241 9501
 Email: ray@sanan-ic.com
 www.sanan-ic.com/en

RFHIC

Tel: +82-31-8069-3105
 Email: grace.cho@rfhic.com
 www.rfhic.com

APPLIED ENERGY SYSTEMS

Tel: +001 610-647-8744
 info@appliedenergysystems.com
 www.appliedenergysystems.com

Pegasus

Tel: +44 (0)1244 521869
 Email: info@pegasuschchemicals.com
 www.pegasuschchemicals.com

Showcase your presence to the global CS industry for 12 months

COMPOUND SEMICONDUCTOR MAGAZINE is the primary information resource for professionals working with compound semiconductor materials and devices.

Each issue of the magazine is distributed in print and digitally to over 60,000 professionals worldwide. With the largest and most diverse global audience of qualified buyers served by any compound semiconductor focused magazine, secure a corporate partnership and buyers guide entry and receive 12 months of promotion and exposure to the compound semiconductor industry across the magazine portfolio including:

- 12 months of promotion in eight issues of the print and digital versions of Compound Semiconductor featuring your company logo and company details
- 12 months of promotion and exposure on the Compound Semiconductor website www.compoundsemiconductor.net featuring a Buyers Guide entry and hyperlinked company logo
- Sponsorship of one e-news alerts sent out to over 60,000 industry professionals with text and a standard web banner.

To find out more, contact: Adam Richardson, Marketing Manager
E: adam.richardson@angelbc.com **T:** +44 (0)2476 718970





There is no alien invasion It's just our Auratus line of Temescal Systems

Our conic-shaped chambers are taking over in compound semiconductor production facilities as the world's leading manufacturers adopt our Auratus™ enhanced line of Temescal electron beam deposition systems. We vaporize metals more efficiently. We deliver uniformity. We return unmatched savings. The results are overwhelming.

With a line of tools optimized for a range of production environments, whether 150mm or 200mm, small-batch or high-volume, this invasion could be coming your way.

Find out more before you take us to your leader.

Contact Ferrotec at 1-925-371-4170 or visit temescal.ferrotec.com/auratus-invasion.



UEFC-4900
25 Wafers (150mm)



UEFC-5700
42 Wafers (150mm)
18 Wafers (200mm)



UEFC-6100
25 Wafers (200mm)